



SLS & MLS SERIES

LINEAR POSITION SENSORS

INNOVATION IN MOTION

The SLS and MLS series of linear position sensors are designed to provide maximum performance benefits within an extremely compact size. Using the proven benefits of Hybrid Track Technology and including a number of innovative design features, these position sensors are ideally suited to applications where high performance and reliability matched by competitive pricing and rapid despatch are of paramount importance.

Hybrid track

The hybrid track comprises a high resistivity conductive plastic film bonded to a precision wire-wound element. The conductive plastic film is wiped by a precious metal contact. The technology provides infinite resolution and a very long life (since the majority of the current still flows in the wire, the carbon content of the conductive plastic film is low, and the film is therefore very hard). Track linearity is very good, temperature coefficient of resistance is low and predictable and resistance stability with change in humidity is excellent. See page 18 for hybrid track operating principle.

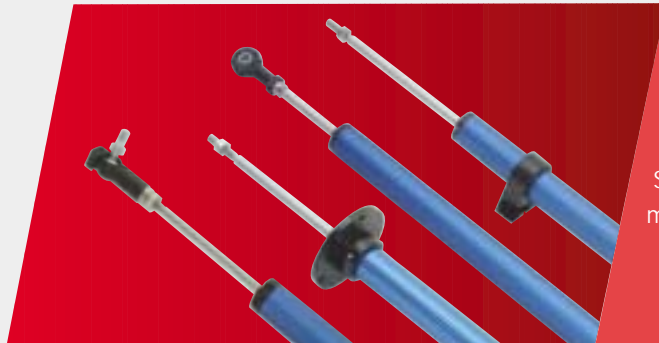
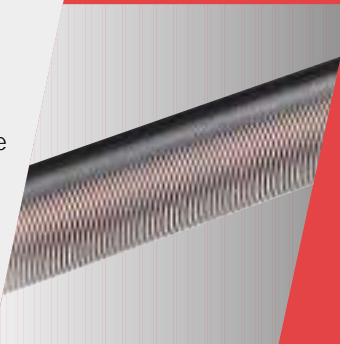

Choice of mounting

A wide choice of mounting options are available and include self-aligning bearings, body clamp kits and flange mounting kits. Spring loaded shaft operation is offered on models SLS130 and SLS220.

Features

- Compact body to stroke length
- Sealing to IP66 and corrosion resistant rod end bearings
- Cable integrally moulded
- Reduced weight
- Rapid despatch
- CE approved

Benefits

- Reduced installation space
- Suitable for hostile environments
- Excellent strain relief with secure sealing
- Ideal for mobile applications
- Eliminates customer inventory
- Confidence in EMC performance



EMC Directive 2004/108/EC

The products detailed in this document have been tested to the requirements of EN61000-6-3 (Emissions) and EN61000-6-2 (Immunity).



Quality Assurance

Penny+Giles are accredited to BS EN ISO9001:2008. Quality is at the heart of all our systems ensuring the reliability of our products from initial design to final despatch.

Certificate No. LRQ 0924881

ATEX 94/9/EC (100a) and 1999/92/EC (137) Directives

Penny+Giles SLS and MLS products are potentiometers and as such are classed as 'simple apparatus' according to the definition in paragraph 3.21 (a) of BS EN60079-14:1997. 'Simple apparatus' is not certified, but may be used as part of an intrinsically safe circuit providing it is used with a suitable interface of associated apparatus (e.g. a safety barrier). A full declaration of compliance can be supplied on request.

Environmental protection

In addition to the IP66 protection that can be selected when ordering, an additional protective sleeve can be specified to protect the operating shaft and enhance the performance of the SLS130, MLS130, SLS190 and SLS320 models, making them especially suited to particularly harsh applications in motor racing, agricultural, material handling, construction, steel manufacturing and structural monitoring applications.

LINEAR POSITION SENSORS

High integrity reduces system cost

Hybrid track technology sensors used in a control system allow simple, low current electronics to be used, while the low hysteresis, low electrical noise and the self-compensating effect for track wear allow the system designer to achieve improved system accuracy and long term integrity without increasing system costs. The technology also enables quick, easy installation.

Availability

The SLS and MLS series of linear position sensors are designed to provide the user with the widest choice of options to suit a wide range of applications. We offer the designer a menu of options so the most suitable type can be selected to suit the control system design. Cell manufacturing allows us to supply in rapid despatch times.

Total reliability

Hybrid track technology provides a highly reliable solution for absolute position sensing problems. The self-cleaning, long life contact design and stable, predictable output of the hybrid track improves service life and reduces the need for regular maintenance or re-calibration of the control system.

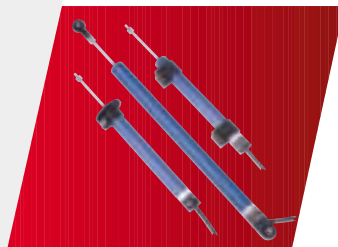

SLS095 Page 4

- Stroke length to 100mm
- 9.5mm body diameter
- Self aligning bearings, body clamp or flange mounting
- Sealed to IP66

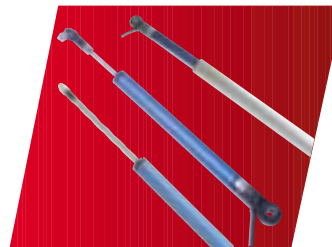

SLS130 Page 6

- Stroke length to 200mm
- 13mm body diameter
- Self aligning bearings, body clamp or flange mounting
- Spring operated shaft fit
- Protective sleeve
- Sealed to IP66

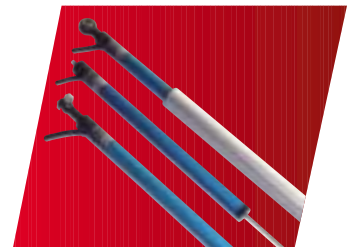

MLS130 Page 8

- Stroke length to 200mm
- 13mm body diameter
- High strength metal rod ends, quick release joints or M4 studs
- Protective sleeve
- Sealed to IP66
- Raychem™DR25 cable

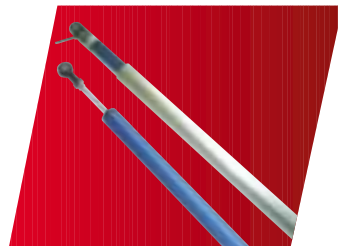

SLS190 Page 10

- Stroke length to 350mm
- 19mm body diameter
- Self aligning bearings, body clamp or flange mounting
- Protective sleeve
- Sealed to IP66

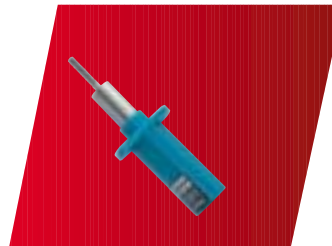

SLS220 Page 12

- Stroke length 10 or 20mm
- 22mm body diameter
- Flange mounting
- Spring loaded operation

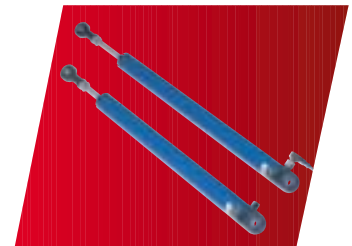

SLS320 Page 14

- Stroke length to 1600mm
- 32mm body diameter
- Self aligning bearings body clamp or flange mounting
- Protective sleeve
- Sealed to IP66

SLS095 LINEAR DISPLACEMENT SENSOR

SLS095 is designed to provide maximum performance benefits within an extremely compact body diameter of 9.5mm, with stroke lengths from 10 to 100mm. The miniature size of this sensor makes it ideal for applications in robotics, animatronics, medical equipment and motorsport data acquisition.

PERFORMANCE

Electrical stroke E	mm	10	20	30	40	50	75	100	
Resistance $\pm 10\%$	k Ω	0.4 [†]	0.8	1.2	1.6	2.0	3.0	4.0	[†] $\pm 15\%$ for SLS 095/10
Independent linearity	$\pm\%$	0.5	0.35	0.25	0.25	0.25	0.15	0.15	
Power dissipation at 20°C	W	0.2	0.4	0.6	0.8	1.0	1.5	2.0	
Applied voltage maximum	Vdc	8.9	17.9	26	40	44	67	74	
Resolution		Virtually infinite							
Hysteresis (repeatability)		Less than 0.01mm							
Operational temperature	°C	-30 to +100							
Output smoothness		To MIL-R-39023 grade C 0.1%							
Insulation resistance		Greater than 100M Ω at 500Vdc							
Operating mode		Voltage divider only - see Circuit Recommendation below							
Wiper circuit impedance		Minimum of 100 x track resistance or 0.5M Ω (whichever is greater)							
Operating force maximum									
sealed	gf	300 in horizontal plane							
unsealed	gf	100 in horizontal plane							
Life at 250mm per second		Typically greater than 100 million operations (50 x 10 ⁶ cycles) at 25mm stroke length							
Dither life		200 million operations (100 x 10 ⁶ cycles) at ± 0.5 mm, 60Hz							
Sealing		IP50 standard - IP66 see options							
Shaft seal life		20 million operations (10 x 10 ⁶ cycles)							
Shaft velocity maximum	m/s	2.5							
Vibration		RTCA 160D 10Hz to 2kHz (random) @ 4.12g (rms) - all axes							
Shock		40g 6ms half sine							

CIRCUIT RECOMMENDATION

Hybrid track potentiometers feature a high wiper contact resistance, therefore operational checks should be carried out only in the voltage divider mode. Hybrid track potentiometers should be used only as voltage dividers, with a minimum wiper circuit impedance of 100 x track resistance or 0.5M Ω (whichever is greater). Operation with wiper circuits of lower impedance will degrade the output smoothness and affect the linearity.

OPTIONS

IP 66 sealing
Mounting

Designed to accept integral shaft seal to give IP66 rating
Can be supplied with self aligning bearings or a plain body for use with body clamps or flange mounting kit.

ACCESSORIES

Mounting kits ———— Body clamp kit - SA200841
Flange kit - SA200842

AVAILABILITY

All standard configurations can be supplied rapidly from the factory - check with your local supplier for more details

ORDERING CODES

SLS095/...../...../...../.....

Electrical stroke ———— Resistance

Sealing 50 = IP50, 66 = IP66
Mounting option R = Self aligning bearing
P = Plain

DIMENSIONS AND MOUNTING OPTIONS

Note: drawings not to scale

SELF ALIGNING BEARING MOUNTING

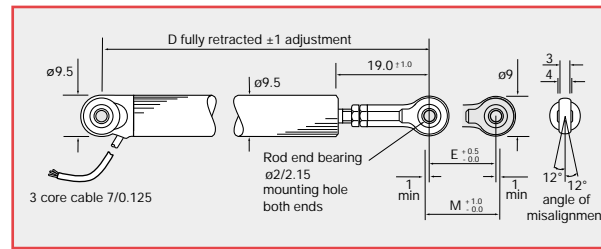

PLAIN BODY MOUNTING

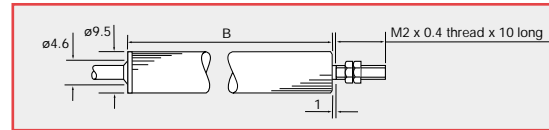

MOUNTING OPTIONS

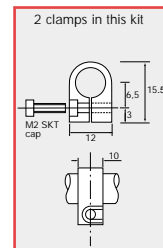

Body clamp
SA200841

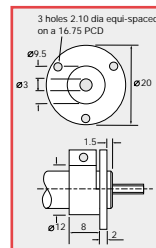

Flange mounting
SA200842

Electrical stroke E	mm	10	20	30	40	50	75	100
Mechanical stroke M	mm	12.5	22.5	32.5	42.5	52.5	77.5	102.5
Body length B	mm	45.5	55.5	65.5	75.5	85.5	110.5	135.5
Between centres D		70	80	90	100	110	135	160
Weight approximate (mounting option R)	g	11	13	14.5	16	17.5	21.5	25.5

ELECTRICAL CONNECTIONS

3 core cable: PUR sheathed 0.3m long with PTFE insulated 7/0.125 cores.

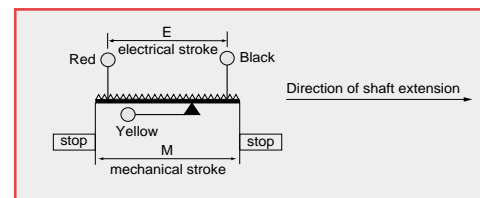

SLS130 LINEAR DISPLACEMENT SENSOR

The SLS130 range is designed to provide performance benefits within a compact, lightweight package in stroke lengths from 25 to 200mm. With a choice of mounting options and accessories, this sensor is ideally suited to a wide range of industrial applications.

PERFORMANCE

		25	50	75	100	125	150	175	200
Electrical stroke E	mm	25	50	75	100	125	150	175	200
Resistance $\pm 10\%$	k Ω	1	2	3	4	5	6	7	8
Independent linearity									
guaranteed	$\pm\%$	0.25	0.25	0.15	0.15	0.15	0.15	0.15	0.15
typical	$\pm\%$	0.15	0.15	0.15	0.10	0.10	0.07	0.07	0.07
Power dissipation at 20°C	W	0.5	1.0	1.5	2.0	2.5	3.0	3.5	4.0
Applied voltage maximum	Vdc	22	44	67	74	74	74	74	74
Electrical output		Minimum of 0.5% to 99.5% applied volts							
Resolution		Virtually infinite							
Hysteresis (repeatability)		Less than 0.01mm							
Operational temperature	°C	-30 to +100 (tested to +130 for 12 hours duration)							
Output smoothness		To MIL-R-39023 grade C 0.1%							
Insulation resistance		Greater than 100M Ω at 500Vdc							
Operating mode		Voltage divider only - see Circuit Recommendation below							
Wiper circuit impedance		Minimum of 100 x track resistance or 0.5M Ω (whichever is greater)							
Operating force maximum									
sealed	gf	500 in horizontal plane							
unsealed	gf	250 in horizontal plane							
Life at 250mm per second		Typically greater than 100 million operations (50 x 10 ⁶ cycles) at 25mm stroke length							
Dither life		200 million operations (100 x 10 ⁶ cycles) at ± 0.5 mm, 60Hz							
Sealing		IP50 standard - IP66 see options							
Shaft seal life		20 million operations (10 x 10 ⁶ cycles) - replaceable							
Shaft velocity maximum	m/s	10							
Vibration		RTCA 160D 10Hz to 2kHz (random) @12.6g (rms) - all axes							
Shock		Less than 0.04% output change @2500g - all axes							

CIRCUIT RECOMMENDATION

Hybrid track potentiometers feature a high wiper contact resistance, therefore operational checks should be carried out only in the voltage divider mode. Hybrid track potentiometers should be used only as voltage dividers, with a minimum wiper circuit impedance of 100 x track resistance or 0.5M Ω (whichever is greater). Operation with wiper circuits of lower impedance will degrade the output smoothness and affect the linearity.

OPTIONS

Compact shaft	Compact shaft will reduce dimension D by 25mm
Integral shaft seal - IP 66	Designed to accept integral shaft seal to give IP66 rating
Extended cable length	10m output cable can be specified
Mounting	Body clamp, flange or quick release balljoint mounting kits can be supplied
Protective sleeve	For all stroke lengths - self aligning bearings only. See ordering code
Spring loaded shaft kit	For stroke lengths 25 to 150mm with /L shaft option only

ACCESSORIES

Mounting kits	<ul style="list-style-type: none"> — Body clamp kit - SA200264, Flange kit - SA200266 — Quick release balljoint (Heim) - SA200337
Protective sleeve - SA202984/...../.....	<ul style="list-style-type: none"> — Shaft L=Long, C=Compact — Electrical stroke (select to match SLS130 sensor)
Spring loaded shaft kit - SA200265/stroke	(For use with option L/50 units only)

AVAILABILITY

All standard configurations can be supplied rapidly from the factory - check with your local supplier for more details

ORDERING CODES

SLS130/...../...../...../...../.....

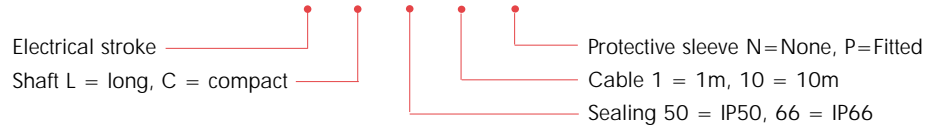

DIMENSIONS AND MOUNTING OPTIONS

Note: drawings not to scale

SELF ALIGNING BEARING MOUNTING

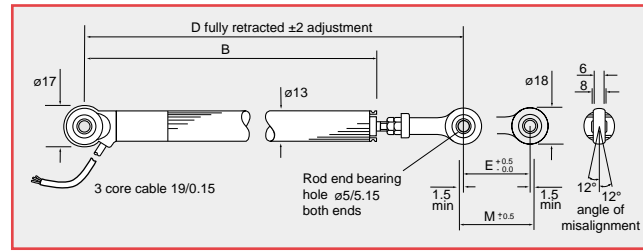

PROTECTIVE SLEEVE OPTION - P

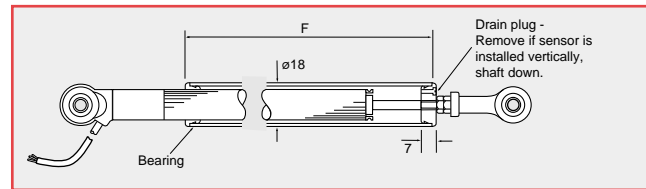

SPRING RETURN OPTION †

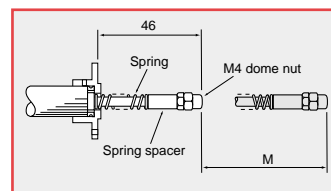

SA200265/stroke
 (25 to 150mm stroke lengths and /L shaft only)

MOUNTING OPTIONS

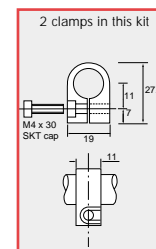

Body clamp
 SA200264

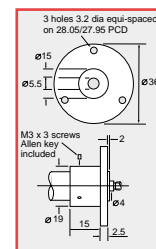

Flange mounting
 SA200266

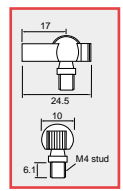

Quick release ball joint
 SA200337

Electrical stroke E	mm	25	50	75	100	125	150	175	200
Mechanical stroke M	mm	29	54	79	104	129	154	179	204
Body length B	mm	110.5	135.5	160.5	185.5	210.5	235.5	260.5	285.5
Between centres D									
standard sensor (L)	mm	173.6	198.6	223.6	248.6	273.6	298.6	323.6	348.6
compact shaft sensor (C)	mm	148.6	173.6	198.6	223.6	248.6	273.6	298.6	323.6
Sleeve length F									
standard sensor (L)	mm	102	127	152	177	202	227	252	277
compact shaft sensor (C)	mm	77	102	127	152	177	202	227	252
Weight approximate									
standard sensor (L)	g	64	71	78	85	92	99	106	113
compact shaft sensor (C)	g	60	67	74	81	88	95	102	109

ELECTRICAL CONNECTIONS

3 core cable: PUR sheathed 1m long with ETFE insulated 19/0.15 cores.

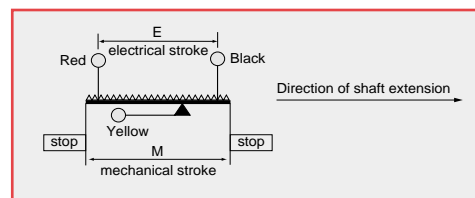

† Body clamp or flange mounting options should be ordered separately

MLS 130 LINEAR DISPLACEMENT SENSOR

The MLS130 sealed linear sensor is designed to provide superior performance within a compact, lightweight package in stroke lengths from 25 to 200mm. With a choice of mounting options, including metal rod end bearings, and an optional protective sleeve for extreme environmental conditions, this sensor is ideally suited to motorsport data acquisition applications on suspension and throttle position feedback, where high performance and reliability with competitive pricing and rapid despatch are vital. The sensor is supplied fully sealed to IP66, with an integrally moulded DR25 sheathed multicore cable.

PERFORMANCE

		25	50	75	100	125	150	175	200
Electrical stroke E	mm	25	50	75	100	125	150	175	200
Resistance $\pm 10\%$	k Ω	1	2	3	4	5	6	7	8
Independent linearity									
guaranteed	$\pm\%$	0.25	0.25	0.15	0.15	0.15	0.15	0.15	0.15
typical	$\pm\%$	0.15	0.15	0.15	0.10	0.10	0.07	0.07	0.07
Power dissipation at 20°C	W	0.5	1.0	1.5	2.0	2.5	3.0	3.5	4.0
Applied voltage maximum	Vdc	22	44	67	74	74	74	74	74
Electrical output		Minimum of 0.5% to 99.5% applied volts							
Resolution		Virtually infinite							
Hysteresis (repeatability)		Less than 0.01mm							
Operational temperature	°C	-30 to +100 (tested to +130 for 12 hours duration)							
Output smoothness		To MIL-R-39023 grade C 0.1%							
Insulation resistance		Greater than 100M Ω at 500Vdc							
Operating mode		Voltage divider only - see Circuit Recommendation below							
Wiper circuit impedance		Minimum of 100 x track resistance or 0.5M Ω (whichever is greater)							
Operating force maximum	gf	500 in horizontal plane							
Sealing		IP66							
Shaft seal life (replaceable)		20 million operations (10 x 10 ⁶ cycles)							
Sensor track life at 0.25m/s		Greater than 100 million operations (50 x 10 ⁶ cycles) at 25mm stroke length							
Sensor track dither life		200 million operations (100 x 10 ⁶ cycles) at ± 0.5 mm, 60Hz							
Shaft velocity maximum	m/s	10							
Vibration		RTCA 160D 10Hz to 2kHz (random) @ 12.6g (rms) - all axes							
Shock		Less than 0.04% output change @ 2500g - all axes							

CIRCUIT RECOMMENDATION

Hybrid track potentiometers feature a high wiper contact resistance, therefore operational checks should be carried out only in the voltage divider mode. Hybrid track potentiometers should be used only as voltage dividers, with a minimum wiper circuit impedance of 100 x track resistance or 0.5M Ω (whichever is greater). Operation with wiper circuits of lower impedance will degrade the output smoothness and affect the linearity.

OPTIONS

Mounting	Metal rod end bearings, quick release balljoints or plain M4 stud
Protective sleeve	Available for all stroke lengths

ACCESSORIES

For maximum installation flexibility the following parts are available to purchase separately:

Metal rod end (rear)	P202605
Metal rod end (shaft)	P202604
Quick release balljoint assembly	SA200337
Locknut, M4	X63 - 072 - 340
Protective sleeve assembly	SA202984/stroke/C

A suitable stud lock compound should be used to secure the rear rod end or balljoint assembly. Use Loctite™ activator 7471 and Loctite™ 648 on metal rod end. Use Loctite™ 382 on quick release balljoint.

AVAILABILITY

All standard configurations can be supplied rapidly from the factory - check with your local supplier for more details

ORDERING CODES

MLS130/...../...../.....

Electrical stroke _____ Protective sleeve N=None, P=Fitted
 Mounting _____
 Q=Quick release balljoints, R=Metal rod end bearings, S=M4 studs

DIMENSIONS AND MOUNTING OPTIONS

Note: drawings not to scale

QUICK RELEASE BALLJOINTS (Q)

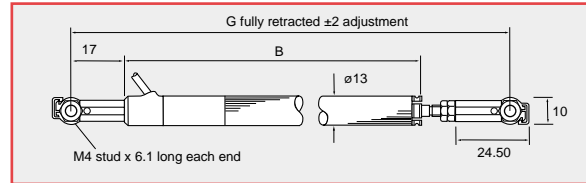

METAL ROD END BEARINGS (R)

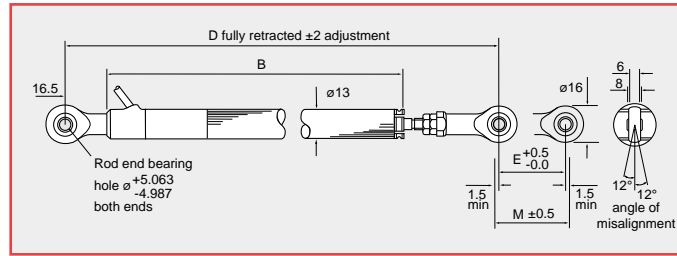

M4 STUD END (S)

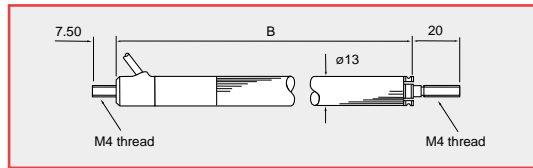

PROTECTIVE SLEEVE (P)

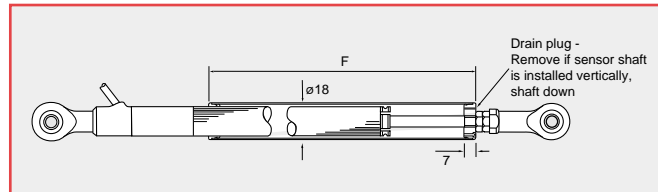

Electrical stroke E	mm	25	50	75	100	125	150	175	200
Mechanical stroke M	mm	29	54	79	104	129	154	179	204
Body length B	mm	110.8	135.8	160.8	185.8	210.8	235.8	260.8	285.8
Between centres D	mm	164.5	189.5	214.5	239.5	264.5	289.5	314.5	339.5
Between centres G	mm	153.6	178.6	203.6	228.6	253.6	278.6	303.6	328.6
Sleeve length F	mm	77	102	127	152	177	202	227	252
Weight approximate	g	80	87	94	101	108	115	122	129

ELECTRICAL CONNECTIONS

3 core cable: DR25 sheathed 1m long with ETFT insulated 19/0.15 cores.

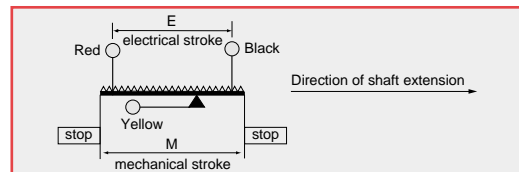

SLS190 LINEAR DISPLACEMENT SENSOR

The SLS190 range is designed to provide maximum performance benefits within a compact package in stroke lengths from 25 to 350mm. With a choice of mounting options and accessories, this sensor is ideally suited to a wide range of general purpose industrial applications, for medium stroke linear position sensing.

PERFORMANCE

		25	50	75	100	125	150	175	200	225	250	275	300	325	350
Electrical stroke E	mm	25	50	75	100	125	150	175	200	225	250	275	300	325	350
Resistance $\pm 10\%$	k Ω	1	2	3	4	5	6	7	8	9	10	11	12	13	14
Independent linearity															
guaranteed	$\pm\%$	0.25	0.25	0.15	0.15	0.15	0.15	0.15	0.15	0.15	0.15	0.15	0.15	0.15	0.15
typical	$\pm\%$	0.15	0.15	0.15	0.10	0.10	0.07	0.07	0.07	0.07	0.05	0.05	0.05	0.05	0.05
Power dissipation at 20°C	W	0.5	1.0	1.5	2.0	2.5	3.0	3.5	4.0	4.5	5.0	5.5	6.0	6.5	7.0
Applied voltage maximum	Vdc	22	44	67	74	74	74	74	74	74	74	74	74	74	74
Electrical output		Minimum of 0.5% to 99.5% applied volts													
Resolution		Virtually infinite													
Hysteresis (repeatability)		Less than 0.01mm													
Operational temperature	°C	-30 to +100 (tested to +130 for 12 hours duration)													
Output smoothness		To MIL-R-39023 grade C 0.1%													
Insulation resistance		Greater than 100M Ω at 500Vdc													
Operating mode		Voltage divider only - see Circuit Recommendation below													
Wiper circuit impedance		Minimum of 100 x track resistance or 0.5M Ω (whichever is greater)													
Operating force maximum															
sealed	gf	500 in horizontal plane													
unsealed	gf	250 in horizontal plane													
Life at 250mm per second		Typically greater than 100 million operations (50 x 10 ⁶ cycles) at 25mm stroke length													
Dither life		200 million operations (100 x 10 ⁶ cycles) at ± 0.5 mm, 60Hz													
Sealing		IP50 standard - IP66 see options													
Shaft seal life		20 million operations (10 x 10 ⁶ cycles) - replaceable													
Shaft velocity maximum	m/s	10													
Vibration		RTCA 160D 10Hz to 2kHz (random) @ 12.6g (rms) - all axes													
Shock		Less than 0.04% output change @ 2500g - all axes													

CIRCUIT RECOMMENDATION

Hybrid track potentiometers feature a high wiper contact resistance, therefore operational checks should be carried out only in the voltage divider mode. Hybrid track potentiometers should be used only as voltage dividers, with a minimum wiper circuit impedance of 100 x track resistance or 0.5M Ω (whichever is greater). Operation with wiper circuits of lower impedance will degrade the output smoothness and affect the linearity.

OPTIONS

Compact shaft	Compact shaft will reduce dimension D by 25mm
Integral shaft seal - IP 66	Designed to accept integral shaft seal to give IP66 rating
Extended cable length	10m output cable can be specified
Mounting	Body clamp or flange mounting kits can be supplied
Protective sleeve	For all stroke lengths - self aligning bearings only. See ordering code

ACCESSORIES

Mounting kits ———— Body clamp kit - SA59019
Flange kit - SA59020

Protective sleeve - SA202986/...../.....

Shaft L = long, C = compact
Electrical stroke (select to match SLS190 sensor)

AVAILABILITY

All standard configurations can be supplied rapidly from the factory - check with your local supplier for more details

SLS220 LINEAR DISPLACEMENT SENSOR

SLS220 linear displacement sensors have a 10mm or 20mm stroke range with a spring loaded operation and a mounting flange to allow easy installation. Contained within a high strength Nylatron® housing, this provides good chemical resistance and low weight. The internal potentiometer assembly is protected to IP66. Suited to OEM and process monitoring applications, this new sensor replaces Penny+Giles HLP220 model.

PERFORMANCE

Electrical stroke E	mm	10	20
Resistance	kΩ	0.4 ±15%	0.8 ±10%
Independent linearity	±%	0.5	0.35
Power dissipation at 20°C	W	0.2	0.4
Applied voltage maximum	Vdc	8.9	17.9
Resolution		Virtually infinite	
Hysteresis (repeatability)		Less than 0.01mm	
Operational temperature	°C	-30 to +100	
Output smoothness		To MIL-R-39023 grade C 0.1%	
Insulation resistance		Greater than 100MΩ at 500Vdc	
Operating mode		Voltage divider only - see Circuit Recommendation below	
Wiper circuit impedance		Minimum of 100 x track resistance or 0.5MΩ (whichever is greater)	
Operating force maximum	kgf	4.0	
Life at 250mm per second		Typically greater than 20 million operations (10 x 10 ⁶ cycles)	
Sealing		Internally sealed to IP66 (spring loaded plunger is unsealed, so care must be taken when selecting for environments which have a risk of particle contamination)	
Shaft velocity maximum	m/s	2.5	

CIRCUIT RECOMMENDATION

Hybrid track potentiometers feature a high wiper contact resistance, therefore operational checks should be carried out only in the voltage divider mode. Hybrid track potentiometers should be used only as voltage dividers, with a minimum wiper circuit impedance of 100 x track resistance or 0.5MΩ (whichever is greater). Operation with wiper circuits of lower impedance will degrade the output smoothness and affect the linearity.

AVAILABILITY

All standard configurations can be supplied rapidly from the factory - check with your local supplier for more details

ORDERING CODES

SLS220/...../.....

Electrical stroke Resistance

DIMENSIONS

Note: drawings not to scale

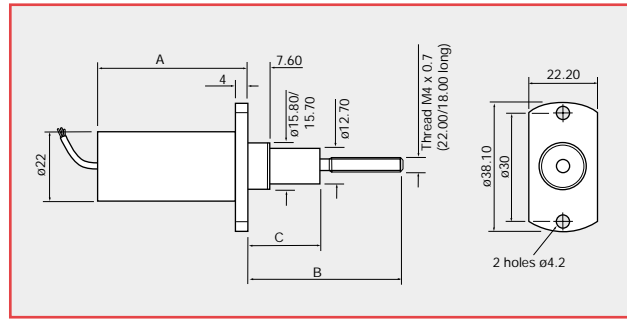

Electrical stroke E	mm	10	20
Mechanical stroke M	mm	12.5	22.5
Body length A	mm	44.4	54.4
Shaft extended - B	mm	43	53
Shaft extended - C	mm	20	30
Weight approximate	g	45	50

Note: Nominal shaft position is fully extended (spring loaded)

MATERIALS

Body	Nylatron® MC901 (blue)
Shaft	Stainless steel

ELECTRICAL CONNECTIONS

3 core cable: PUR sheathed 0.3m long with PTFE insulated 7/0.125 cores.

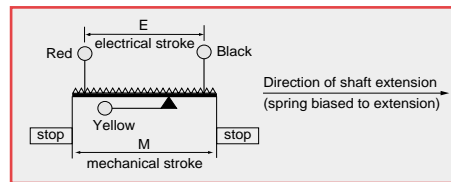

SLS320 LINEAR DISPLACEMENT SENSOR

The SLS320 range is designed to provide maximum performance benefits within a body diameter of 32mm, with stroke lengths from 250 to 1600mm. With a choice of mounting options and accessories, this sensor is ideally suited to a wide range of heavier duty industrial applications, for medium to long stroke linear position sensing.

PERFORMANCE

Electrical stroke E	mm	250	300	350	400	450	500	550	600	650	700	750	800	850	900
Resistance $\pm 10\%$	k Ω	10	12	14	16	18	20	22	24	26	28	30	32	34	36
Power dissipation at 20°C	W	5.0	6.0	7.0	8.0	9.0	10	11	12	13	14	15	16	17	18
Electrical stroke E	mm	950	1000	1050	1100	1150	1200	1250	1300	1350	1400	1450	1500	1550	1600
Resistance $\pm 10\%$	k Ω	38	40	42	44	46	48	50	52	54	56	58	60	62	64
Power dissipation at 20°C	W	19	20	21	22	23	24	25	26	27	28	29	30	31	32
Independent linearity															
guaranteed	$\pm\%$	0.15													
typical	$\pm\%$	0.05													
Applied voltage - maximum	Vdc	74													
Electrical output		Minimum of 0.5% to 99.5% applied volts													
Resolution		Virtually infinite													
Hysteresis (repeatability)	mm	Less than 0.01													
Operational temperature	°C	-30 to +100													
Output smoothness		To MIL-R-39023 grade C 0.1%													
Insulation resistance		Greater than 100M Ω at 500Vdc													
Operating mode		Voltage divider only - see Circuit Recommendation below													
Wiper circuit impedance		Minimum of 100 x track resistance or 0.5M Ω (whichever is greater)													
Operating force - maximum															
sealed	gf	2000 in horizontal plane (break-out force 5000gf)													
unsealed	gf	1500 in horizontal plane (break-out force 2000gf)													
Life at 250mm per second		Typically in excess of 100 million operations (50 x 10 ⁶ cycles) at 25mm stroke length													
Dither life		200 million operations (100 x 10 ⁶ cycles) at ± 0.5 mm, 60Hz													
Sealing		IP50 standard - IP66 see options													
Shaft seal life		20 million operations (10 x 10 ⁶ cycles) - replaceable													
Shaft velocity - maximum	m/s	10													

CIRCUIT RECOMMENDATION

Hybrid track potentiometers feature a high wiper contact resistance, therefore operational checks should be carried out only in the voltage divider mode. Hybrid track potentiometers should be used only as voltage dividers, with a minimum wiper circuit impedance of 100 x track resistance or 0.5M Ω (whichever is greater). Operation with wiper circuits of lower impedance will degrade the output smoothness and affect the linearity.

OPTIONS

Compact shaft	Compact shaft will reduce dimension D by 50mm
Integral shaft seal - IP 66	Designed to accept integral shaft seal to give IP66 rating
Cabled socket	1m or 10m cabled socket assemblies available
Mounting	Body clamp or flange mounting kits can be supplied
Protective sleeve	For all stroke lengths - self aligning bearings only. See ordering code

ACCESSORIES

Mounting kits 

Protective sleeve - SA202988/...../.....

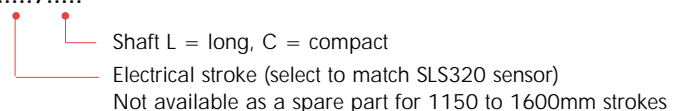

 Shaft L = long, C = compact
 Electrical stroke (select to match SLS320 sensor)
 Not available as a spare part for 1150 to 1600mm strokes

AVAILABILITY

All standard configurations can be supplied rapidly from the factory - check with your local supplier for more details

ORDERING CODES

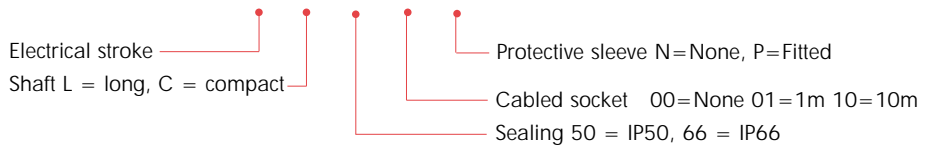
SLS320/...../...../...../...../.....



DIMENSIONS AND MOUNTING OPTIONS

Note: drawings not to scale

Mounting recommendations

For units 1150 to 1600mm stroke, we recommend the use of body clamp or flange mounting kits to support the sensor when horizontally mounted. Alternatively, use the protective sleeve kit with the self aligning bearing mountings to provide increased rigidity.

SELF ALIGNING BEARING MOUNTING

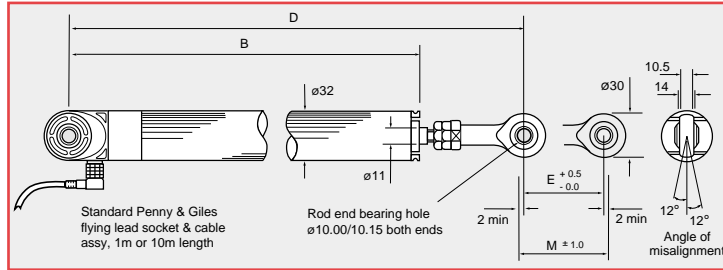

MOUNTING OPTIONS

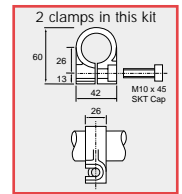

Body clamp
SA59661

Flange mounting
SA59660

PROTECTIVE SLEEVE OPTION - P

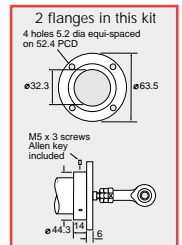
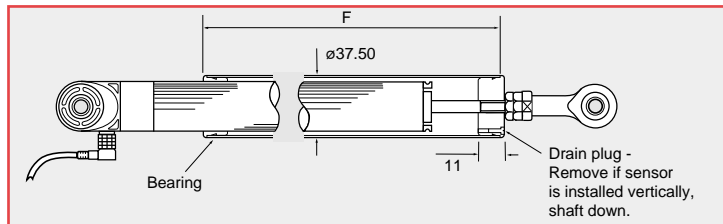

Electrical stroke E	mm	250	300	350	400	450	500	550	600	650	700	750	800	850	900
Mechanical stroke M	mm	255	305	355	405	455	505	555	605	655	705	755	805	855	905
Body length B	mm	366	416	466	516	601	651	701	751	801	851	901	986	1036	1086
Between centres D															
standard sensor (L)	mm	480	530	580	630	710	760	810	860	910	960	1010	1095	1145	1195
compact shaft sensor (C)	mm	430	480	530	580	660	710	760	810	860	910	960	1045	1095	1145
Sleeve length F															
standard sensor (L)	mm	372	422	472	522	607	657	707	757	807	857	907	992	1042	1092
compact shaft sensor (C)	mm	322	372	422	472	557	607	657	707	757	807	857	942	992	1042
Weight approximate (no sleeve)															
standard sensor (L)	g	590	673	756	839	922	1005	1088	1171	1254	1337	1420	1503	1586	1669
compact shaft sensor (C)	g	555	638	721	804	887	970	1053	1136	1219	1302	1385	1468	1551	1634
Electrical stroke E	mm	950	1000	1050	1100	1150	1200	1250	1300	1350	1400	1450	1500	1550	1600
Mechanical stroke M	mm	955	1005	1055	1105	1155	1205	1255	1305	1355	1405	1455	1505	1555	1605
Body length B	mm	1136	1186	1236	1286	1371	1421	1471	1521	1571	1621	1671	1721	1771	1821
Between centres D															
standard sensor (L)	mm	1245	1295	1345	1395	1480	1530	1580	1630	1680	1730	1780	1830	1880	1930
compact shaft sensor (C)	mm	1195	1245	1295	1345	1430	1480	1530	1580	1630	1680	1730	1780	1830	1880
Sleeve length F															
standard sensor (L)	mm	1142	1192	1242	1292	1377	1427	1477	1527	1577	1627	1677	1727	1777	1827
compact shaft sensor (C)	mm	1092	1142	1192	1242	1327	1377	1427	1477	1527	1577	1627	1677	1727	1777
Weight approximate (no sleeve)															
standard sensor (L)	g	1752	1835	1918	2000	2095	2190	2285	2380	2475	2570	2665	2760	2855	2950
compact shaft sensor (C)	g	1717	1800	1883	1965	2060	2155	2250	2345	2440	2535	2630	2725	2820	2915

ELECTRICAL CONNECTIONS

Right angled, cabled socket

E series M12 to IEC 60947-5-2 PUR jacket.
Conforms to DIN/VDE 0660 part 208A2

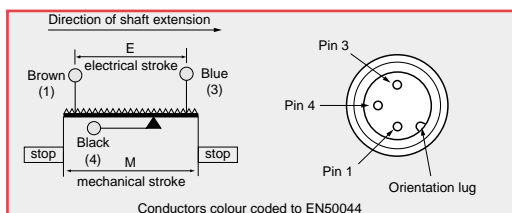

Cabled Socket

1 metre long No. x61-169-001
(Hirschmann No. 933 316-021/1m)
10 metres long No. x61-169-010
(Hirschmann No. 933 316-021/10m)

SPECIALISED DESIGNS

We have considerable experience in solving specific application problems by developing our standard designs to suit individual requirements. Custom-designed solutions are also provided where standard equipment does not fully meet our customer's needs.

SLS320 for heavy duty-cycle dynamic applications

A number of specialist applications have demanded an enhanced operating life beyond that capable from the standard SLS320 sealed linear sensor. To meet this requirement, we have developed a special version of the SLS320, which provides optimum lubrication for the track and sliding mechanism for increased operating life.

Typically the sensors are mounted parallel to actuators fitted to hydraulic motion bases operating leisure ride cabins at amusement parks around the world. Typically the motion bases run a three minute cycle time for up to 12 hours per day. This sensor is ideally suited to similar applications subject to heavy duty dynamic movements.

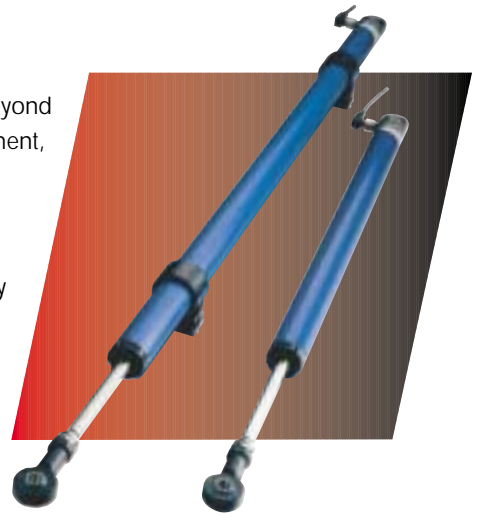

SPECIFICATION SUMMARY

Refer to page 14 and 15 for full performance specification and dimensions

Electrical stroke E	mm	150 to 1600mm only
Sealing		IP66 or IP50
Shaft seal life		20 million operations (10 x 10 ⁶) - replaceable
Shaft velocity - maximum	m/s	10

OPTIONS

Compact shaft	Compact shaft will reduce dimension D (page 15) by 50mm
Cabled socket	1m or 10m cabled socket assemblies available
Mounting	Self aligning rod ends standard. Body clamp and flange kits available
Protective sleeve	For 250 to 1600mm stroke lengths - self aligning bearings only.

ACCESSORIES

Mounting kits ———— [Body clamp kit - SA59661
Flange kit - SA59660

Protective sleeve - SA202988/...../.....

Shaft L = long, C = compact
Electrical stroke (select to match SLS320 sensor)
Not available as a spare part for 1150 to 1600mm strokes

Clamp sleeve (to allow SLS320 to replace Penny+Giles HLP350 in existing installations) - P200863 (2 per sensor)

AVAILABILITY

All standard configurations can be supplied rapidly from the factory - check with your local supplier for more details

ORDERING CODES

D46273/...../...../...../...../.....

Electrical stroke ————
Shaft L = long, C = compact ————
Protective sleeve N=None, P=Fitted
Cabled socket 00=None 01=1m 10=10m
Sealing 50 = IP50, 66 = IP66

IN-CYLINDER LINEAR POSITION SENSORS

ICS100 In-Cylinder Sensors

Suitable for actuator strokes up to 1600mm

A range of In-Cylinder linear position sensors designed for integration into hydraulic and pneumatic actuators where the sensor is fitted inside the pressurised environment. Using the proven benefits of Hybrid Track Technology and including a number of innovative design features, the ICS100 range is ideally suited to high volume OEM actuator manufacturers, where design engineers can specify an affordable alternative for applications where non-contacting technologies may prove too expensive.

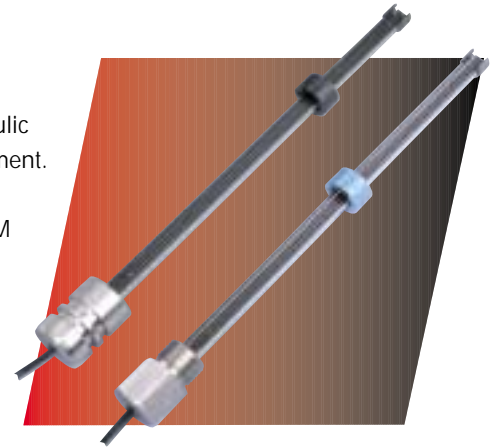

SPECIFICATION SUMMARY

Ask for our ICS100 In-Cylinder Sensors brochure for full details and designers guide.

It can also be downloaded from our website at www.pennyandgiles.com

Electrical length E	mm	25 to 200 in 5mm increments 210 to 1100 in 10mm increments (Up to 1600mm can be specified. See options)
Independent linearity	±%	0.25 for 25 to 70mm lengths 0.15 for 75 to 1600mm lengths
Resolution		Virtually infinite
Hysteresis (repeatability)		Less than 0.01mm
Operational temperature	°C	-30 to +100
Output smoothness		To MIL-R-39023 grade C 0.1%
Life		Typically greater than 100 million operations (50 x 10 ⁶ cycles) at 25mm stroke length
Dither life		200 million operations (100 x 10 ⁶ cycles) at ±0.5mm 60Hz
Slider velocity - maximum	m/s	10 in pneumatic applications 4 in hydraulic applications (ISO Vg 32 mineral oil)
Pressure - working	Bar	500 maximum
burst	Bar	> 700
pulsed	Bar	0 to 500 in 1 second (tested to 25,000 cycles)
Working fluid		Tested for mineral oils only. Not recommended for water based fluids

OPTIONS

Electrical length	Length from 1110mm up to 1600mm can also be supplied in 10mm increments. Please discuss your application with our sales team before ordering.
Mounting	Internal or external flange styles can be specified
Cylinder environment	Hydraulic (H) or Pneumatic (P) versions can be specified
Extended cable length	1m or 10m output cable can be specified

AVAILABILITY

All standard configurations can be supplied rapidly from the factory - check with your local supplier for more details

SPRING RETURN LINEAR DISPLACEMENT SENSOR

HLP190 Linear Potentiometers

The HLP190 range of hybrid linear potentiometers provides the facility for single or dual electrical output with a body diameter of only 19mm. Stroke lengths are from 25mm to 150mm, with a choice of body clamp (BS) or flange (FS) mounting. This model is supplied with a spring loaded shaft, biased to the fully extended position. Suited to a wide range of industrial applications for medium stroke length requirements – especially structural monitoring data acquisition.

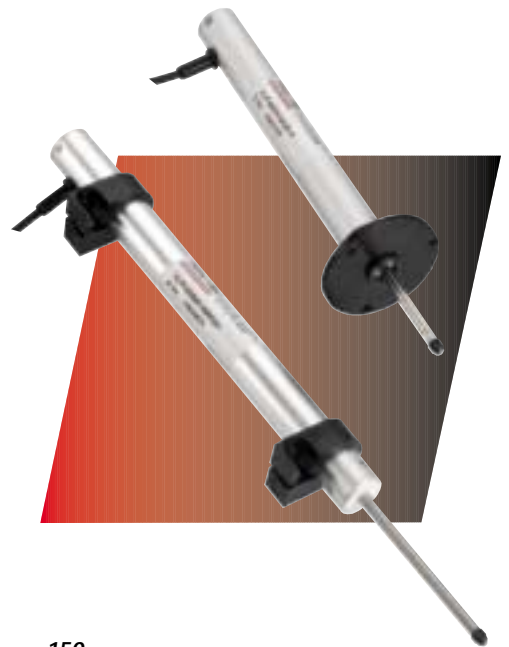

PERFORMANCE

Electrical stroke E	mm	25	50	75	100	125	150
Resistance $\pm 10\%$	k Ω	1	2	3	4	5	6
Independent linearity	$\pm\%$	0.3	0.3	0.2	0.2	0.2	0.2
Power dissipation at 20°C	W	0.5	1.0	1.5	2.0	2.5	3.0
Applied voltage maximum	Vdc	22	44	67	74	74	74
Electrical output		Single or dual – minimum of 0.5% to 99.5% applied volts					
Resolution		Virtually infinite					
Hysteresis (repeatability)		Less than 0.01mm					
Phasing between elements		0.5mm total in retracted position (multi output units)					
Operational temperature	°C	-30 to +85					
Output smoothness		To MIL-R-39023 grade C 0.1%					
Insulation resistance		Greater than 100M Ω at 500Vdc					
Operating mode		Voltage divider only - see Circuit Recommendation below					
Wiper circuit impedance		Minimum of 100 x track resistance or 0.5M Ω (whichever is greater)					
Operating force maximum	gf	450	475	500	525	550	600
Life at 250mm per second		Typically greater than 100 million operations (50 x 10 ⁶ cycles) at 25mm stroke length					
Shaft velocity maximum	m/s	1					
Shaft seal		No seal fitted due to spring loaded probe action					

CIRCUIT RECOMMENDATION

Hybrid track potentiometers feature a high wiper contact resistance, therefore operational checks should be carried out only in the voltage divider mode. Hybrid track potentiometers should be used only as voltage dividers, with a minimum wiper circuit impedance of 100 x track resistance or 0.5M Ω (whichever is greater). Operation with wiper circuits of lower impedance will degrade the output smoothness and affect the linearity.

OPTIONS

Mounting	Body clamp (BS) or flange (FS)
Outputs	Single (1) or dual (2)
Stroke length	25 to 150mm in 25mm increments
Resistance	Standard value is 1k Ω per 25mm. Alternative values are possible – contact our sales team to discuss your application

AVAILABILITY

All standard configurations can be supplied rapidly from the factory - check with your local supplier for more details

ORDERING CODES

HLP190/...../...../...../.....

Mounting BS = Body clamp
 FS = Flange

Output 1 = Single
 2 = Dual

Stroke length mm

Resistance

DIMENSIONS AND MOUNTING OPTIONS

Note: drawings not to scale

BODY CLAMP MOUNTING WITH SPRING LOADED SHAFT - HLP190/BS

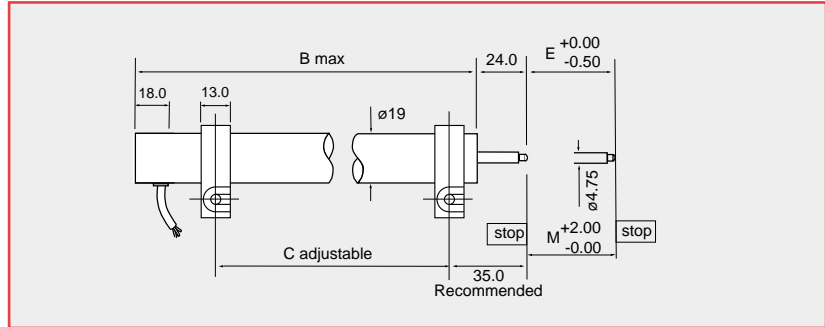

FLANGE MOUNTING WITH SPRING LOADED SHAFT - HLP190/FS

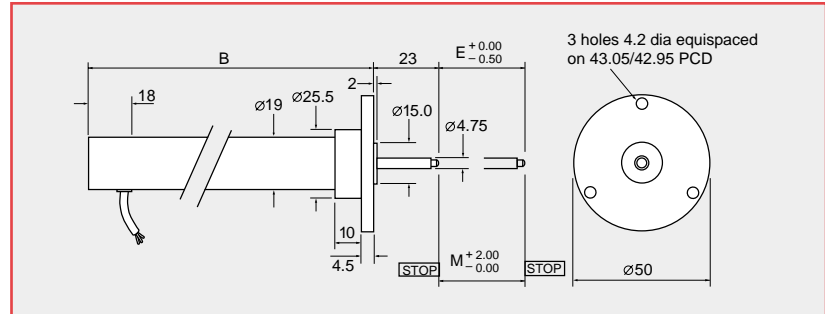

Body clamp detail

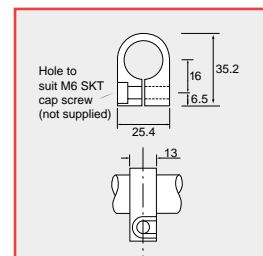

Mechanical stroke M	mm	25	50	75	100	125	150
Body length B							
Type BS	mm	155	205	230	255	305	355
Type FS	mm	156	206	231	256	306	356
Clamp spacing C[†]	mm	114	164	189	214	264	314
Weight approximate							
Type BS	g	115	135	150	180	195	210
Type FS	g	120	140	155	185	200	215

[†] recommended position

ELECTRICAL CONNECTIONS

3 core cable: PVC sheathed 0.5m long with ETFE insulated 19/0.15 cores (6 core cable for dual output version)

Single output

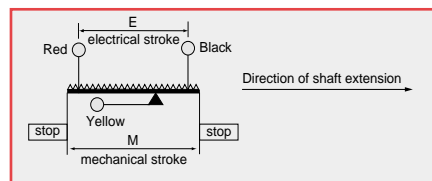

Dual output

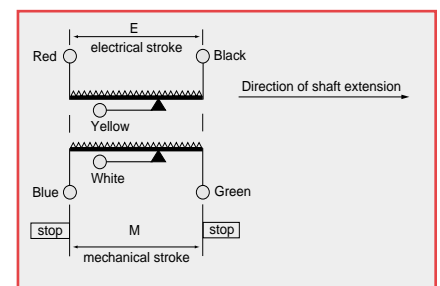



www.pennyandgiles.com

Penny & Giles

Position sensors, joysticks and solenoids for commercial and industrial applications.

15 Airfield Road
Christchurch
Dorset BH23 3TG
United Kingdom
+44 (0) 1202 409409
+44 (0) 1202 409475 Fax
sales@pennyandgiles.com

36 Nine Mile Point Industrial Estate
Cwmfelinfach
Gwent NP11 7HZ
United Kingdom
+44 (0) 1495 202000
+44 (0) 1495 202006 Fax
sales@pennyandgiles.com

665 North Baldwin Park Boulevard
City of Industry CA 91746
USA
+1 626 480 2150
+1 626 369 6318 Fax
us.sales@pennyandgiles.com

Straussenlettenstr. 7b
85053 Ingolstadt,
Germany
+49 (0) 841 61000
+49 (0) 841 61300 Fax
info@penny-giles.de

The information contained in this brochure on product applications should be used by customers for guidance only. Penny+Giles Controls Ltd makes no warranty or representation in respect of product fitness or suitability for any particular design application, environment, or otherwise, except as may subsequently be agreed in a contract for the sale and purchase of products. Customer's should therefore satisfy themselves of the actual performance requirements and subsequently the products suitability for any particular design application and the environment in which the product is to be used.

Continual research and development may require change to products and specification without prior notification. All trademarks acknowledged.

© Penny+Giles Controls Ltd 2010

Innovation In Motion

