



Push-To-Connect







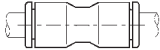

Push-To-Connect

Brennan's new line of Push-To-Connect pneumatic fittings allows instant connections just by pushing the tube into the fitting. No tools or other operations are necessary, and disconnections are just as easy.

These universally adapted fittings are ideal for both mobile and in-plant applications involving compressed air. The fittings are available in both poly and nickel-plated brass. They're also offered for metric tubes with BSP threads in taper, parallel and metric form.

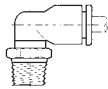
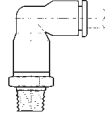
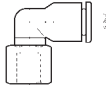
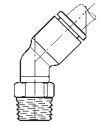
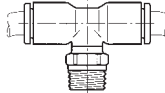
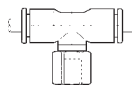
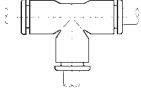
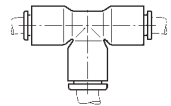
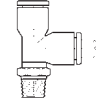

Brennan offers Push-To-Connect fittings in a wide range of body designs and configurations — from 1/8" to 1/2" diameters. All are in stock now and available for immediate delivery. And all feature the same consistent quality you've come to expect from Brennan.

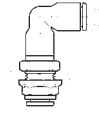
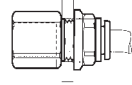
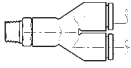
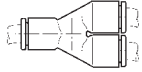
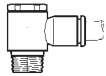
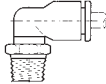
Nylon Push-To-Connect Fittings For Industrial Applications



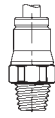
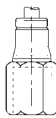
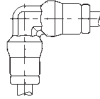
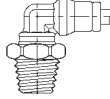
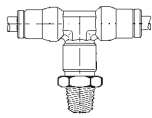
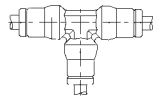
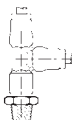
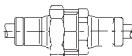
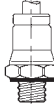
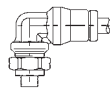
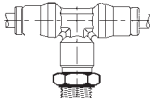
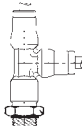

 <p>2403 Union - Fractional Inch Tube To Tube</p>	 <p>2403 Unequal Union - Fractional Inch Tube To Tube</p>	 <p>2404 Male Connector - Fractional Inch Tube To Male NPT</p>	 <p>2405 Straight Female Connector - Fractional Inch Tube To NPT</p>	 <p>2500 Union Elbow - Fractional Inch To Tube</p>	 <p>2500 Unequal Union Elbow - Fractional Inch Tube To Tube</p>
 <p>2501 Male Elbow - Fractional Inch Tube To Male NPT</p>	 <p>2501 Extended Male Elbow - Fractional Inch Tube To Male NPT</p>	 <p>2502 Female Elbow - Fractional Inch Tube To NPT</p>	 <p>2503 45° Male Elbow - Fractional Inch Tube To Male NPT or UNF</p>	 <p>2601 Male Branch Tee - Fractional Inch Tube To Male NPT or UNF To Tube</p>	 <p>2602 Female Branch Tee - Fractional Inch Tube To Male NPT</p>
 <p>2603 Tee - Fractional Inch Tube To Tube To Tube</p>	 <p>2603 Unequal Tee - Fractional Inch Tube To Tube To Tube</p>	 <p>2605 Male Run Tee - Fractional Inch Tube To Tube To Male NPT or UNF</p>	 <p>2700 Bulkhead Union - Tube To Tube</p>	 <p>2701 Equal Bulkhead Elbow - Tube To Tube</p>	 <p>2705 Female Bulkhead Connector - Tube To NPT</p>
 <p>2801 "Y" Male - Fractional Inch Tube To NPT</p>	 <p>2803 "Y" - Fractional Inch Tube To Tube</p>	 <p>2805 Banjo - Fractional Inch Tube To NPT</p>	 <p>6400 Male Elbow - Fractional Inch Tube To UNF</p>		

Push-To-Connect

Nickel-Plated Brass Push-To-Connect Fittings For Industrial Applications

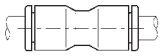
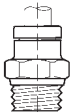
 <p>2403 Straight Union - Fractional Inch Tube To Tube</p>	 <p>2404 Male Connector - Fractional Inch Tube To NPT</p>	 <p>2405 Female Connector - Fractional Inch Tube To NPT</p>	 <p>2500 Union Elbow - Fractional Inch Tube To Tube</p>	 <p>2501 Male Elbow - Fractional Inch Tube To NPT</p>	 <p>2601 Male Branch Tee - Fractional Inch Tube To NPT To Tube</p>
 <p>2603 Union Tee - Fractional Inch Tube To Tube To Tube</p>	 <p>2605 Male Run Tee - Fractional Inch Tube To Tube To NPT</p>	 <p>2700 Bulkhead Connector - Fractional Inch Tube To Tube</p>	 <p>6400 Male Connector - Fractional Inch Tube To UNF</p>	 <p>6801 Male Elbow - Fractional Inch Tube To UNF</p>	 <p>6803 Male Branch Tee - Fractional Inch Tube To UNF To Tube</p>
 <p>6804 Male Run Tee - Fractional Inch Tube To Tube To UNF</p>	 <p>2406 Plug-In Reducer - Fractional Inch</p>				

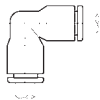
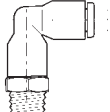
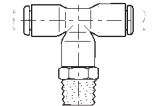
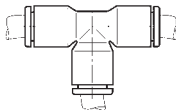
SAE and DOT Push-To-Connect Fittings For Vehicle Applications

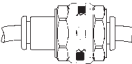
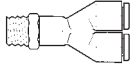
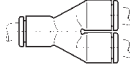
 <p>2403 Union - Fractional Inch Tube To Tube</p>	 <p>2404 Male Connector - Fractional Inch Tube To Male NPT</p>	 <p>2405 Straight Female Connector - Fractional Inch Tube To NPT</p>	 <p>2500 Union Elbow - Fractional Inch Tube To Tube</p>	 <p>2501 Male Elbow - Fractional Inch Tube To Male NPT</p>	 <p>2601 Male Branch Tee - Fractional Inch Tube To Male NPT</p>
 <p>2603 Union Tee - Fractional Inch Tube To Tube To Tube</p>	 <p>2605 Male Run Tee - Fractional Inch Tube To Male NPT</p>	 <p>2700 Bulkhead Union - Fractional Inch</p>	 <p>2801 "Y" Male Connector - Fractional Inch Tube To NPT</p>	 <p>2803 Union "Y" - Fractional Inch Tube To Tube</p>	

Nylon Push-To-Connect Fittings For Industrial Applications

Union – Fractional Inch Tube To Tube

ØD in	Cat. No.	G in	L in	Scale oz
1/8	PCNY2403-02-02	.34	.97	.11
5/32	PCNY2403-02.5-02.5	.33	.98	.07
3/16	PCNY2403-03-03	.43	1.44	.39
1/4	PCNY2403-04-04	.43	1.16	.14
5/16	PCNY2403-05-05	.53	1.50	.25
3/8	PCNY2403-06-06	.63	1.65	.40
1/2	PCNY2403-08-08	.87	2.17	.95

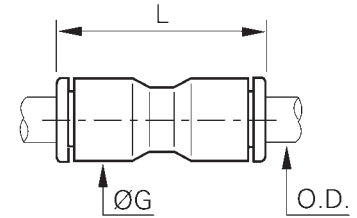

Unequal Union – Fractional Inch Tube To Tube

ØD1 in	ØD2 in	Cat. No.	G in	L in	Scale oz
1/8	5/32	PCNY2403-02-02.5	.33	.96	.11
1/8	1/4	PCNY2403-02-04	.43	1.32	.34
5/32	1/4	PCNY2403-02.5-04	.43	1.16	.34
1/4	5/16	PCNY2403-04-05	.53	1.44	.40
3/8	1/4	PCNY2403-06-04	.63	1.61	.50
3/8	1/2	PCNY2403-06-08	.87	2.17	.55

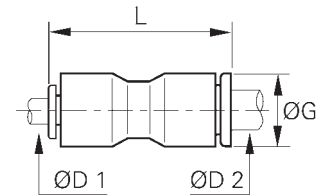

Male Connector – Fractional Inch Tube To Male NPT

ØD1 in	C NPT	Cat. No.	F1 mm	F2 in	H in	K in	Scale oz
1/8	1/16	PCNY2404-02-01	10	.07	.413	.433	.24
1/8	1/8	PCNY2404-02-02	11	.07	.283	.472	.25
1/8	1/4	PCNY2404-02-04	14	.07	.315	.591	.59
5/32	1/8	PCNY2404-02.5-02	11	7/64	.334	.472	.26
5/32	1/4	PCNY2404-02.5-04	14	7/64	.275	.590	.56
3/16	1/8	PCNY2404-03-02	7/16"	1/8	.61	.51	.49
3/16	1/4	PCNY2404-03-04	9/16"	5/32	.59	.65	.97
1/4	1/8	PCNY2404-04-02	11	5/32	.472	.472	.26
1/4	1/4	PCNY2404-04-04	14	5/32	.374	.590	.50
1/4	3/8	PCNY2404-04-06	18	3/16	.295	.767	.88
5/16	1/8	PCNY2404-05-02	13	3/16	.787	.551	.45
5/16	1/4	PCNY2404-05-04	14	1/4	.661	.590	.58
5/16	3/8	PCNY2404-05-06	18	1/4	.464	.767	.89
3/8	1/8	PCNY2404-06-02	16	5/32	.894	.689	.79
3/8	1/4	PCNY2404-06-04	16	9/32	.807	.689	.73
3/8	3/8	PCNY2404-06-06	18	9/32	.689	.767	.97
3/8	1/2	PCNY2404-06-08	22	9/32	.610	.945	2.00
1/2	1/4	PCNY2404-08-04	22	1/4	1.1	.945	1.62
1/2	3/8	PCNY2404-08-06	22	9/32	1.1	.945	.89
1/2	1/2	PCNY2404-08-08	22	9/32	1.1	.945	2.51

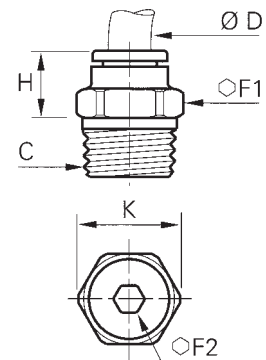

Push-To-Connect

Straight Female Connector – Fractional Inch Tube To NPT

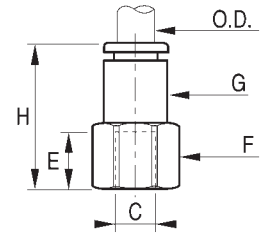

ØD in	C NPT	Cat. No.	F mm	G in	H in	E in	Scale oz
1/8	1/8	PCNY2405-02-02	13	.43	.87	.37	.48
1/8	1/4	PCNY2405-02-04	16	.43	1.05	.55	.74
5/32	1/8	PCNY2405-02.5-02	13	.33	.89	.37	.37
5/32	1/4	PCNY2405-02.5-04	16	.33	1.06	.55	.65
3/16	1/8	PCNY2405-03-02	9/16		1.06		.76
3/16	1/4	PCNY2405-03-04	11/16		1.26		1.01
1/4	1/8	PCNY2405-04-02	13	.42	.98	.37	.44
1/4	1/4	PCNY2405-04-04	16	.42	1.16	.55	.66
5/16	1/8	PCNY2405-05-02	13	.53	1.14	.37	.55
5/16	1/4	PCNY2405-05-04	16	.53	1.32	.55	.85
3/8	1/8	PCNY2405-06-02	16	.61	1.22	.37	.94
3/8	1/4	PCNY2405-06-04	16	.61	1.40	.55	.94
3/8	3/8	PCNY2405-06-06	22	.61	1.52	.65	1.85
1/2	3/8	PCNY2405-08-06	22	.85	1.81	.65	3.25
1/2	1/2	PCNY2405-08-08	24	.85	1.93	.77	4.02

Union Elbow – Fractional Inch To Tube

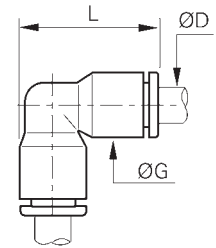

ØD in	Cat. No.	G in	L in	Scale oz
1/8	PCNY2500-02-02	.33	.71	.11
5/32	PCNY2500-02.5-02.5	.33	.75	.07
3/16	PCNY2500-03-03	.43	1.07	.55
1/4	PCNY2500-04-04	.43	.93	.15
5/16	PCNY2500-05-05	.53	1.16	.25
3/8	PCNY2500-06-06	.63	1.33	.41
1/2	PCNY2500-08-08	.87	1.38	.65

Unequal Union Elbow – Fractional Inch Tube To Tube

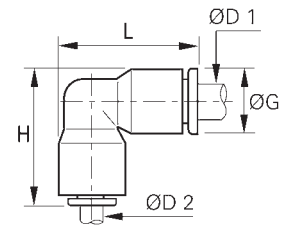

ØD1 in	ØD2 in	Cat. No.	G in	H in	L in	Scale oz
1/8	1/4	PCNY2500-02-04	.43	.93	.93	.20
5/32	1/4	PCNY2500-02.5-04	.43	.93	.93	.25
3/8	1/4	PCNY2500-06-04	.63	1.30	1.33	.50
3/8	1/2	PCNY2500-06-08	.87	1.81	1.81	.65

Male Elbow – Fractional Inch Tube To Male NPT

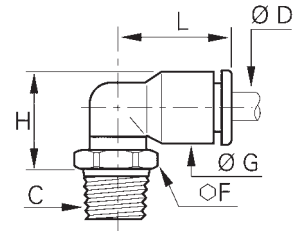

ØD in	C NPT	Cat. No.	F1 mm	G in	H in	L in	Scale oz
1/8	1/16	PCNY2501-02-01	10	.34	.53	.57	.23
1/8	1/8	PCNY2501-02-02	11	.34	.53	.57	.29
1/8	1/4	PCNY2501-02-04	14	.34	.55	.57	.63
5/32	1/8	PCNY2501-02.5-02	11	.33	.53	.55	.28
5/32	1/4	PCNY2501-02.5-04	14	.33	.55	.55	.62
3/16	1/8	PCNY2501-03-02	11	.43	.67	.85	.45
1/4	1/8	PCNY2501-04-02	11	.43	.67	.71	.32
1/4	1/4	PCNY2501-04-04	14	.43	.63	.71	.51
1/4	3/8	PCNY2501-04-06	18	.43	.65	.71	.79
5/16	1/8	PCNY2501-05-02	11	.53	.75	.91	.29
5/16	1/4	PCNY2501-05-04	14	.53	.71	.91	.58
5/16	3/8	PCNY2501-05-06	18	.53	.73	.91	.81
3/8	1/8	PCNY2501-06-02	15	.63	.91	1.08	.60
3/8	1/4	PCNY2501-06-04	15	.63	.91	1.08	.74
3/8	3/8	PCNY2501-06-06	18	.63	.87	1.08	.96
3/8	1/2	PCNY2501-06-08	22	.63	.91	1.08	1.69
1/2	1/4	PCNY2501-08-04	20	.87	1.22	1.38	1.42
1/2	3/8	PCNY2501-08-06	20	.87	1.22	1.38	1.44
1/2	1/2	PCNY2501-08-08	24	.87	1.12	1.38	1.89

Extended Male Elbow – Fractional Inch Tube To Male NPT

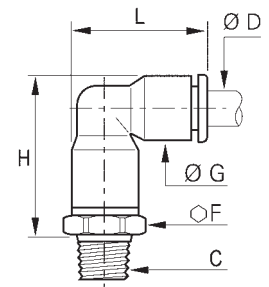

ØD in	C NPT	Cat. No.	F mm	G in	H in	L in	Scale oz
1/8	1/8	PCNY2501-L-02-02	11	.33	.91	.75	.36
1/8	1/4	PCNY2501-L-02-04	14	.33	.93	.75	.68
5/32	1/8	PCNY2501-L-02.5-02	11	.33	.91	.75	.37
5/32	1/4	PCNY2501-L-02.5-04	14	.33	.93	.75	.69
1/4	1/8	PCNY2501-L-04-08	11	.43	1.12	.93	.51
1/4	1/4	PCNY2501-L-04-04	14	.43	1.08	.93	.73
1/4	3/8	PCNY2501-L-04-06	17	.43	1.12	.93	.80
5/16	1/8	PCNY2501-L-05-02	13	.53	1.32	1.16	.73
5/16	1/4	PCNY2501-L-05-04	14	.53	1.28	1.16	.93
3/8	1/8	PCNY2501-L-06-02	17	.63	1.40	1.34	1.30
3/8	1/4	PCNY2501-L-06-04	17	.63	1.41	1.33	1.41
3/8	3/8	PCNY2501-L-06-06	18	.63	1.45	1.33	1.73

Push-To-Connect

Female Elbow – Fractional Inch Tube To NPT

ØD in	C NPT	Cat. No.	F mm	G in	H in	E in	L in	Scale oz
1/8	1/8	PCNY2502-02-02	13	.34	.91	.37	.57	.38
5/32	1/8	PCNY2502-02.5-02	13	.33	.91	.37	.55	.41
5/32	1/4	PCNY2502-02.5-04	16	.33	1.08	.55	.55	.14
1/4	1/8	PCNY2502-04-02	13	.43	1.02	.37	.71	.47
1/4	1/4	PCNY2502-04-04	16	.43	1.18	.55	.71	.38
5/16	1/8	PCNY2502-05-02	13	.53	1.12	.37	.91	.50
5/16	1/4	PCNY2502-05-04	16	.53	1.28	.55	.91	.85
3/8	1/4	PCNY2502-06-04	16	.63	1.52	.55	1.04	.90
1/2	3/8	PCNY2502-08-06	22	.87	1.88	.65	1.38	2.47

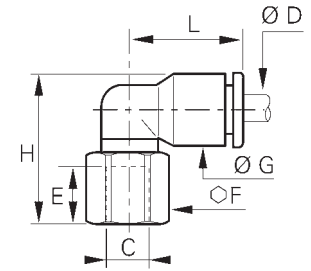

45° Male Elbow – Fractional Inch Tube To Male NPT or UNF

ØD in	C UNF/NPT	Cat. No.	F mm	G in	H in	L in	Scale oz
1/8	10-32	PCNY2503-02-10/32	8	.35	.91	.49	.28
1/8	1/8	PCNY2503-02-02	11	.35	.81	.49	.28
1/4	1/8	PCNY2503-04-02	11	.43	.98	.57	.28
1/4	1/4	PCNY2503-04-04	14	.43	.98	.57	.60
1/4	M7	PCNY2503-04-07	9	.43	1.14	.57	.28
3/8	1/4	PCNY2503-06-04	17	.63	1.36	.91	.71
3/8	3/8	PCNY2503-06-06	18	.63	1.36	.91	.81

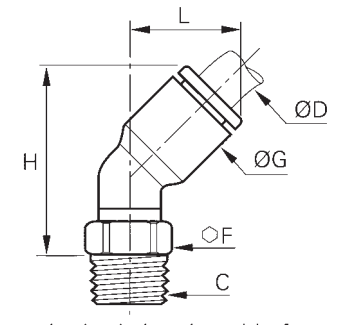

Male Branch Tee – Fractional Inch Tube To Male NPT or UNF To Tube

ØD in	C UNF/NPT	Cat. No.	F mm	G in	H in	L 2 in	Scale oz
1/8	10-32	PCNY2601-02-02-02.5	8	.33	.61	.57	.23
1/8	1/16	PCNY2601-02-02-01	10	.33	.61	.57	.27
1/8	1/8	PCNY2601-02-02-02	11	.33	.61	.57	.33
1/8	1/4	PCNY2601-02-02-04	14	.33	.63	.57	.66
5/32	10-32	PCNY2601-02.5-02.5-10/32	8	.33	.71	.55	.18
5/32	1/8	PCNY2601-02.5-02.5-02	11	.33	.61	.55	.32
5/32	1/4	PCNY2601-02.5-02.5-04	14	.33	.63	.55	.65
3/16	1/8	PCNY2601-03-03-02	11	.43	.67	.85	.64
1/4	1/8	PCNY2601-04-04-02	11	.43	.67	.71	.39
1/4	1/4	PCNY2601-04-04-04	14	.43	.63	.71	.56
1/4	3/8	PCNY2601-04-04-06	18	.43	.65	.71	.85
5/16	1/8	PCNY2601-05-05-02	11	.53	.87	.91	.49
5/16	1/4	PCNY2601-05-05-04	14	.53	.83	.91	.66
5/16	3/8	PCNY2601-05-05-06	18	.53	.85	.91	.97
3/8	1/8	PCNY2601-06-06-02	15	.63	.99	1.04	.81
3/8	1/4	PCNY2601-06-06-04	15	.63	.99	1.04	.88
3/8	3/8	PCNY2601-06-06-06	18	.63	.95	1.04	1.18
3/8	1/2	PCNY2601-06-06-08	22	.63	.98	1.04	1.86
1/2	1/4	PCNY2601-08-08-04	20	.87	1.22	1.38	1.88
1/2	3/8	PCNY2601-08-08-06	20	.87	1.22	1.38	1.93
1/2	1/2	PCNY2601-08-08-08	24	.87	1.12	1.38	2.35

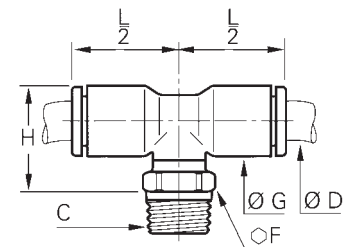

Female Branch Tee – Fractional Inch Tube To Male NPT

ØD in	C NPT	Cat. No.	F mm	G in	H in	E in	L 2 in	Scale oz
1/8	1/8	PCNY2602-02-02-02	13	.34	.99	.37	.57	1.02
5/32	1/8	PCNY2602-02.5-02.5-02	13	.33	.91	.37	.55	.43
5/32	1/4	PCNY2602-02.5-02.5-04	16	.33	1.08	.55	.55	.74
1/4	1/8	PCNY2602-04-04-02	13	.43	1.02	.37	.71	.55
1/4	1/4	PCNY2602-04-04-04	16	.43	1.18	.55	.71	.84
5/16	1/8	PCNY2602-05-05-02	13	.53	1.24	.37	.91	.66
5/16	1/4	PCNY2602-05-05-04	16	.53	1.40	.55	.91	1.01
3/8	1/4	PCNY2602-06-06-04	16	.63	1.60	.55	1.04	1.13
1/2	3/8	PCNY2602-08-08-06	22	.87	1.88	.65	1.38	2.94

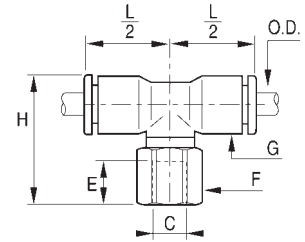

Tee – Fractional Inch Tube To Tube To Tube

ØD in	Cat. No.	G in	H in	L 2 in	Scale oz
1/8	PCNY2603-02-02-02	.33	.75	.57	.15
5/32	PCNY2603-02.5-02.5-02.5	.33	.75	.57	.14
3/16	PCNY2603-03-03-03	.43	1.07	.85	.58
1/4	PCNY2603-04-04-04	.43	.89	.93	.22
5/16	PCNY2603-05-05-05	.53	1.16	.91	.32
3/8	PCNY2603-06-06-06	.63	1.34	1.02	.64
1/2	PCNY2603-08-08-08	.87	1.81	1.38	1.74

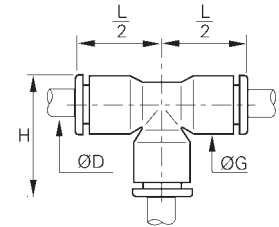

Unequal Tee – Fractional Inch Tube To Tube To Tube

ØD1 in	ØD2 in	Cat. No.	G in	H in	L 2 in	Scale oz
1/8	1/4	PCNY2603-02-02-04	.43	.93	.71	.20
5/32	1/4	PCNY2603-02.5-02.5-04	.43	.93	.71	.28
1/4	1/8	PCNY2603-04-04-02	.43	.93	.73	.35
1/4	5/32	PCNY2603-04-04-02.5	.43	.93	.73	.40
1/4	3/8	PCNY2603-04-04-06	.63	1.32	.96	.60
3/8	1/4	PCNY2603-06-06-04	.63	1.28	1.00	.65
3/8	1/2	PCNY2603-06-06-08	.87	1.81	1.38	.70
1/2	1/4	PCNY2603-08-08-04	.87	1.81	1.38	.73
1/2	3/8	PCNY2603-08-08-06	.87	1.81	1.38	.75

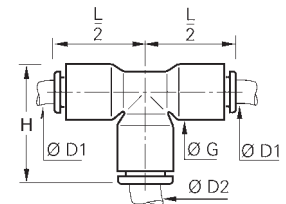

Push-To-Connect

Male Run Tee – Fractional Inch Tube To Tube To Male NPT or UNF

ØD in	C NPT/UNF	Cat. No.	F mm	G in	H in	H1 in	L in	Scale oz
1/8	10-32	PCNY2605-02-10/32-02	8	.33	.92	.35	.57	.19
1/8	1/16	PCNY2605-02-01-02	10	.33	.93	.35	.57	.24
1/8	1/8	PCNY2605-02-02-02	11	.33	.93	.35	.57	.31
5/32	10-32	PCNY2605-02.5-10/32-02.5	8	.33	1.02	.45	.57	.18
5/32	1/8	PCNY2605-02.5-02-02.5	11	.33	.93	.53	.57	.32
5/32	1/4	PCNY2605-02.5-04-02.5	14	.33	.94	.37	.57	.64
3/16	1/8	PCNY2605-03-02-03	11	.45	1.31	.45	.85	.63
1/4	1/8	PCNY2605-04-02-04	11	.43	1.16	.45	.69	.39
1/4	1/4	PCNY2605-04-04-04	14	.43	1.12	.41	.69	.58
1/4	3/8	PCNY2605-04-06-04	18	.43	1.14	.43	.69	.84
5/16	1/8	PCNY2605-05-02-05	11	.53	1.38	.49	.91	.50
5/16	1/4	PCNY2605-05-04-05	14	.53	1.34	.45	.91	.69
5/16	3/8	PCNY2605-05-06-05	18	.53	1.36	.47	.91	.97
3/8	1/8	PCNY2605-06-02-06	15	.63	1.63	.60	1.04	.81
3/8	1/4	PCNY2605-06-04-06	15	.63	1.63	.60	1.04	.81
3/8	3/8	PCNY2605-06-06-06	18	.63	1.60	.55	1.04	1.19
3/8	1/2	PCNY2605-06-08-06	22	.63	1.63	.59	1.04	1.97
1/2	1/4	PCNY2605-08-04-08	20	.87	2.17	.79	1.38	1.85
1/2	3/8	PCNY2605-08-06-08	20	.87	2.17	.79	1.38	1.93
1/2	1/2	PCNY2605-08-08-08	24	.87	2.07	.79	1.38	2.19

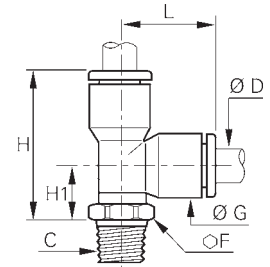

Bulkhead Union – Tube To Tube

ØD in	Cat. No. (fractional inch)	F mm	K max in	L1 in	L2 in	T min in	Scale oz	Max Torque
1/8	PCNY2700-02-02	13	.22	.37	.61	.41	.64	11 lb. in.
5/32	PCNY2700-02.5-02.5	13	.22	.59	.39	.41	.67	11 lb. in.
1/4	PCNY2700-04-04	16	.35	.37	.81	.53	.24	13 lb. in.
5/16	PCNY2700-05-05	18	.57	.98	.53	.61	1.16	15 lb. in.
3/8	PCNY2700-06-06	22	.57	.51	1.18	.73	.65	22 lb. in.
1/2	PCNY2700-08-08	29	.81	.67	1.61	1.00	3.60	

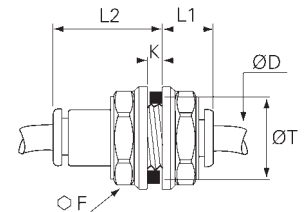

Equal Bulkhead Elbow – Tube To Tube

ØD in	Cat. No. (fractional inch)	F1 mm	F2 mm	G in	H in	K max in	L in	T min in	Scale oz
1/8	PCNY2701-02-02	13	13	.35	.71	.28	.57	.41	.67
5/32	PCNY2701-02.5-02.5	–	13	.33	.83	.26	.67	.41	.67
1/4	PCNY2701-04-04	18	17	.43	.87	.32	.71	.61	.85
5/16	PCNY2701-05-05	–	18	.53	1.22	.31	.94	.61	1.23
3/8	PCNY2701-06-06	22	22	.63	1.08	.33	1.00	.73	2.80
1/2	PCNY2701-08-08	29	27	.87	1.54	.41	1.38	1.00	4.34

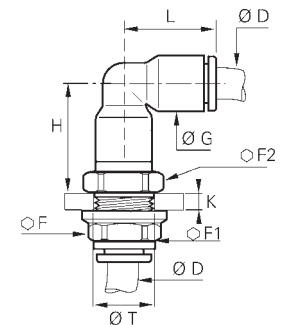

Female Bulkhead Connector – Tube To NPT

ØD in	C NPT	Cat. No. (fractional inch)	E in	F1 mm	F2 mm	K max in	L1 in	L2 in	T min in	Scale oz
1/8	1/8	PCNY2705-02-02	.37	13	13	.28	.41	.73	.41	.75
5/32	1/8	PCNY2705-02-02.5	.37	13	13	.28	.41	.73	.41	.88
5/32	1/4	PCNY2705-04-02.5	.55	13	16	.32	.41	.73	.41	.99
1/4	1/8	PCNY2705-02-04	.37	18	17	.32	.55	.96	.61	1.23
1/4	1/4	PCNY2705-04-04	.55	18	17	.32	.55	1.18	.61	1.41
3/8	1/4	PCNY2705-04-06	.55	22	22	.33	.57	.89	.73	2.57
3/8	3/8	PCNY2705-06-06	.55	22	22	.33	.57	.89	.73	2.65

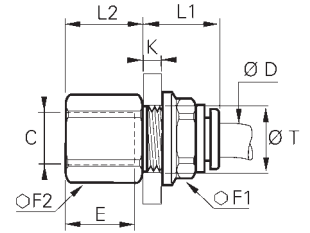

“Y” Male – Fractional Inch Tube To NPT

ØD in	C NPT	Cat. No.	F mm	H in	K in	L in	N in	Scale oz
5/32	1/8	PCNY2801-02.5-02.5-02	11	1.28	.33	.69	.35	.42
5/32	1/4	PCNY2801-02.5-02.5-04	14	1.30	.33	.69	.35	.79
1/4	1/8	PCNY2801-04-04-02	11	1.61	.43	.87	.45	.59
1/4	1/4	PCNY2801-04-04-04	14	1.56	.43	.87	.45	.80
3/8	1/4	PCNY2801-06-06-04	17	2.24	.63	1.30	.67	1.61
3/8	3/8	PCNY2801-06-06-06	18	2.28	.63	1.30	.67	1.94

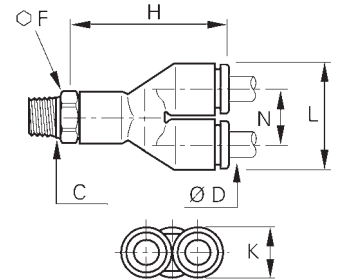

“Y” – Fractional Inch Tube To Tube

ØD1 in	ØD2 in	Cat. No.	H in	K in	L in	N in	Scale oz
1/8	1/8	PCNY2803-02-02	.69	.33	1.12	.35	.16
5/32	5/32	PCNY2803-02.5-02.5	.69	.34	1.12	.35	.14
1/4	1/4	PCNY2803-04-04	.87	.43	1.42	.45	.24
5/16	5/16	PCNY2803-05-05	1.10	.53	1.77	.57	.46
3/8	3/8	PCNY2803-06-06	1.30	.63	2.09	.67	.59
1/8	1/4	PCNY2803-02-04	.87	.43	1.42	.45	.20
5/32	1/4	PCNY2803-02.5-04	.87	.43	1.42	.45	.43
1/4	3/8	PCNY2803-04-06	1.30	.63	1.31	.67	.50
3/8	1/2	PCNY2803-06-08	1.30	.63	2.09	.67	.59

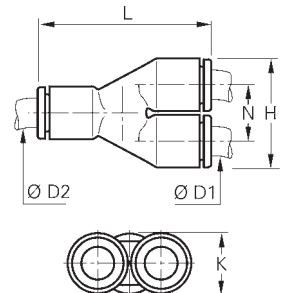

Push-To-Connect

Banjo – Fractional Inch Tube To NPT

ØD in	C NPT	Cat. No.	F mm	G in	H in	L1 in	L2 in	Scale oz
5/32	1/8	PCNY2805-02.5-02	13	.33	.73	.28	.73	.72
1/4	1/8	PCNY2805-04-02	13	.43	.73	.28	.83	.75
1/4	1/4	PCNY2805-04-04	17	.43	.89	.37	.91	1.41
1/4	3/8	PCNY2805-04-06	21	.43	1.04	.43	1.12	2.60
3/8	1/4	PCNY2805-06-04	17	.63	.89	.37	1.12	2.34
3/8	3/8	PCNY2805-06-06	21	.63	1.04	.43	1.20	2.37

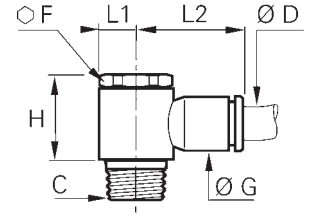

Male Elbow – Fractional Inch Tube To UNF

ØD in	C UNF	Cat. No.	F mm	G in	H in	L in	Scale oz
1/8	10-32	PCNY6400-02-10/32-0	8	.34	.52	.57	.14
5/32	10-32	PCNY6400-02.5-10/32-0	8	.33	.53	.55	.14
1/4	10-32	PCNY6400-04-10/32-0	11	.43	.63	.71	.26

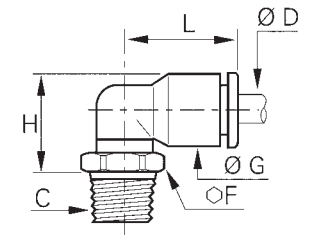

Nickel-Plated Brass Push-To-Connect Fittings For Industrial Applications

Straight Union – Fractional Inch Tube To Tube

ØD in	Cat. No.	G in	L in	Scale oz
5/32	PCNB2403-02.5-02.5	.39	1.20	.35
1/4	PCNB2403-04-04	.49	1.44	.58
5/16	PCNB2403-05-05	.59	1.48	.76
3/8	PCNB2403-06-06	.67	1.87	1.31
1/2	PCNB2403-08-08	.79	1.89	1.49

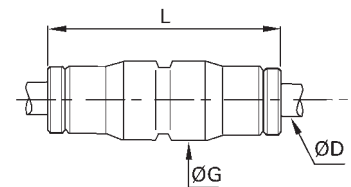

Male Connector – Fractional Inch Tube To NPT

ØD in	C NPT	Cat. No.	E in	F1 mm	F2 mm	H in	K in	Scale oz
5/32	1/8	PCNB2404-02.5-02	.30	13	3	.59	.47	.34
5/32	1/4	PCNB2404-02.5-04	.43	14	3	.59	.59	.61
1/4	1/8	PCNB2404-04-02	.30	13	4	.67	.55	.42
1/4	1/4	PCNB2404-04-04	.43	14	4	.67	.59	.62
1/4	3/8	PCNB2404-04-06	.45	18	5	.67	.77	1.00
3/8	1/8	PCNB2404-06-02	.30	18	4	.97	.77	.89
3/8	1/4	PCNB2404-06-04	.43	18	7	.95	.77	1.04
3/8	3/8	PCNB2404-06-06	.45	18	8	.91	.77	1.16
3/8	1/2	PCNB2404-06-08	.59	22	8	.95	.94	2.03
1/2	1/4	PCNB2404-08-04	.43	22	7	.95	.94	1.42
1/2	3/8	PCNB2404-08-06	.45	22	9	.95	.94	1.49
1/2	1/2	PCNB2404-08-08	.59	22	10	.95	.94	1.77

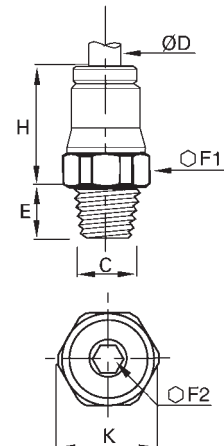

Female Connector – Fractional Inch Tube To NPT

ØD in	C NPT	Cat. No.	E in	F mm	H in	K in	Scale oz
5/32	1/8	PCNB2405-02.5-02	.37	14	.98	.59	.60
5/32	1/4	PCNB2405-02.5-04	.55	17	1.16	.73	1.02
1/4	1/8	PCNB2405-04-02	.37	14	1.10	.59	.55
1/4	1/4	PCNB2405-04-04	.55	17	1.28	.73	1.15
3/8	1/4	PCNB2405-06-04	.55	17	1.50	.73	1.32
3/8	3/8	PCNB2405-06-06	.55	22	1.50	.94	1.97
1/2	3/8	PCNB2405-08-06	.55	22	1.52	.94	2.42
1/2	1/2	PCNB2405-08-08	.73	24	1.67	1.02	2.42

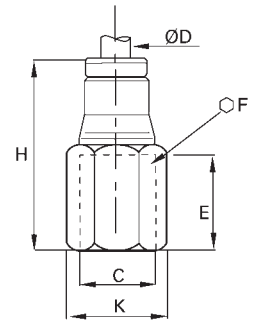

Union Elbow – Fractional Inch Tube To Tube

ØD in	Cat. No.	G in	J in	L in	Scale oz
5/32	PCNB2500-02.5-02.5	.39	.28	.91	.37
1/4	PCNB2500-04-04	.49	.32	1.12	.60
5/16	PCNB2500-05-05	.59	.39	1.22	.81
3/8	PCNB2500-06-06	.67	.47	1.48	1.39
1/2	PCNB2500-08-08	.79	.59	1.61	1.71

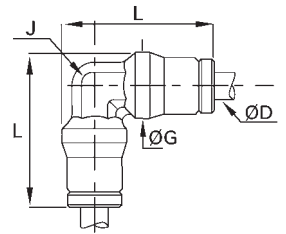

Male Elbow – Fractional Inch Tube To NPT

ØD in	C NPT	Cat. No.	E in	F mm	G in	H in	J in	K in	L in	Scale oz
5/32	1/8	PCNB2501-02.5-02	.30	13	.39	.59	.28	.47	.71	.47
5/32	1/4	PCNB2501-02.5-04	.43	14	.39	.67	.28	.59	.71	.71
1/4	1/8	PCNB2501-04-02	.30	13	.49	.69	.32	.47	.87	.62
1/4	1/4	PCNB2501-04-04	.43	14	.49	.75	.32	.59	.87	.81
1/4	3/8	PCNB2501-04-06	.45	18	.49	.75	.32	.77	.87	1.12
3/8	1/8	PCNB2501-06-02	.30	13	.67	.93	.47	.47	1.14	1.29
3/8	1/4	PCNB2501-06-04	.43	15	.67	.93	.47	.63	1.14	1.40
3/8	3/8	PCNB2501-06-06	.45	18	.67	1.02	.47	.77	1.14	1.57
3/8	1/2	PCNB2501-06-08	.59	22	.67	1.06	.47	.94	1.14	2.27
1/2	1/4	PCNB2501-08-04	.43	15	.79	1.14	.59	.63	1.22	1.65
1/2	3/8	PCNB2501-08-06	.45	18	.79	1.14	.59	.77	1.22	1.90
1/2	1/2	PCNB2501-08-08	.59	22	.79	1.14	.59	.94	1.22	2.41

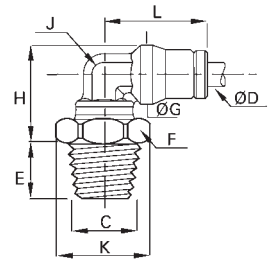

Push-To-Connect

Male Branch Tee – Fractional Inch Tube To NPT To Tube

ØD in	C NPT	Cat. No.	E in	F mm	G in	H in	J in	K in	L in	Scale oz
5/32	1/8	PCNB2601-02.5-02.5-02	.30	13	.39	.97	.28	.47	.71	.71
5/32	1/4	PCNB2601-02.5-02.5-04	.43	14	.39	1.04	.28	.60	.71	1.07
1/4	1/8	PCNB2601-04-04-02	.30	13	.49	1.18	.32	.55	.87	1.16
1/4	1/4	PCNB2601-04-04-04	.43	14	.49	1.22	.32	.60	.87	1.38
1/4	3/8	PCNB2601-04-04-06	.45	18	.49	1.22	.32	.77	.87	1.60
3/8	1/4	PCNB2601-06-06-04	.43	18	.67	1.54	.47	.77	1.14	2.57
3/8	3/8	PCNB2601-06-06-06	.45	18	.67	1.61	.47	.77	1.14	2.82
3/8	1/2	PCNB2601-06-06-08	.59	22	.67	1.61	.47	.94	1.14	3.29
1/2	1/4	PCNB2601-08-08-04	.43	18	.79	1.61	.59	.94	1.22	3.12
1/2	3/8	PCNB2601-08-08-06	.45	22	.79	1.85	.59	.94	1.22	3.53
1/2	1/2	PCNB2601-08-08-08	.59	22	.79	1.89	.59	.94	1.22	4.00

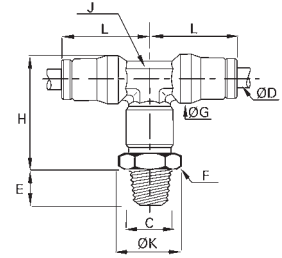

Union Tee – Fractional Inch Tube To Tube To Tube

ØD in	Cat. No.	G in	H in	J in	L in	Scale oz
5/32	PCNB2603-02.5-02.5-02.5	.39	.91	.28	.71	.52
1/4	PCNB2603-04-04-04	.49	1.12	.32	.87	.89
5/16	PCNB2603-05-05-05	.59	1.22	.39	.93	1.13
3/8	PCNB2603-06-06-06	.67	1.48	.47	1.14	1.99
1/2	PCNB2603-08-08-08	.79	1.61	.59	1.22	2.31

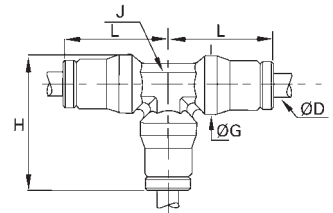

Male Run Tee – Fractional Inch Tube To Tube To NPT

ØD in	C NPT	Cat. No.	E in	F mm	G in	H1 in	H2 in	J in	K in	L in	Scale oz
5/32	1/8	PCNB2605-02.5-02-02.5	.30	13	.39	.71	.77	.28	.47	.91	.71
5/32	1/4	PCNB2605-02.5-04-02.5	.43	14	.39	.71	.85	.28	.59	.91	1.07
1/4	1/8	PCNB2605-04-02-04	.30	13	.49	.87	.93	.32	.55	1.12	1.16
1/4	1/4	PCNB2605-04-04-04	.43	14	.49	.87	.97	.32	.59	1.12	1.38
1/4	3/8	PCNB2605-04-06-04	.45	18	.49	.87	.97	.32	.77	1.12	1.60
3/8	1/4	PCNB2605-06-04-06	.43	18	.67	1.14	1.20	.47	.77	1.48	2.57
3/8	3/8	PCNB2605-06-06-06	.45	18	.67	1.14	1.28	.47	.77	1.48	2.82
3/8	1/2	PCNB2605-06-08-06	.59	22	.67	1.14	1.28	.47	.94	1.48	3.29
1/2	1/4	PCNB2605-08-04-08	.43	18	.79	1.22	1.46	.59	.94	1.61	3.27
1/2	3/8	PCNB2605-08-06-08	.45	22	.79	1.22	1.46	.59	.94	1.61	3.53
1/2	1/2	PCNB2605-08-08-08	.59	22	.79	1.22	1.50	.59	.94	1.61	4.00

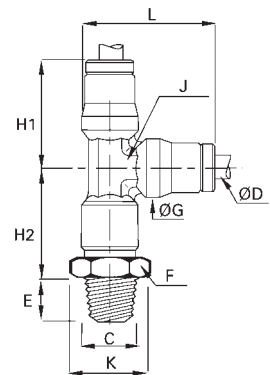

Bulkhead Connector – Fractional Inch Tube To Tube

ØD in	Cat. No.	F1 mm	F2 mm	K in	L1 in	L2 in	T in	Scale oz
5/32	PCNB2700-02.5-02.5	13	14	.55	.55	.79	.49	.69
1/4	PCNB2700-04-04	16	17	.69	.67	.89	.59	1.00
5/16	PCNB2700-05-05	18	19	.77	.73	.93	.67	1.27
3/8	PCNB2700-06-06	22	27	.95	.87	1.10	.85	2.22
1/2	PCNB2700-08-08	24	24	1.02	.89	1.14	1.04	2.97

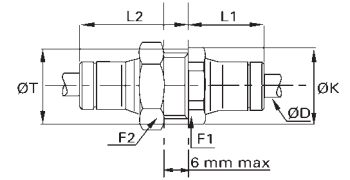

Male Connector – Fractional Inch Tube To UNF

ØD in	C UNF	Cat. No.	E in	F1 mm	F2 mm	H in	K in	Scale oz
5/32	10-32	PCNB6400-02.5-10/32-0	.13	10	2.5	.63	.43	.28
1/4	10-32	PCNB6400-04-10/32-0	.13	13	2.5	.79	.55	.35

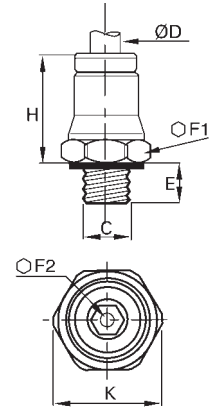

Male Elbow – Fractional Inch Tube To UNF

ØD in	C UNF	Cat. No.	E in	F mm	G in	H in	J in	K in	L in	Scale oz
5/32	10-32	PCNB6801-02.5-10/32-0	.13	10	.39	.71	.28	.43	.71	.39

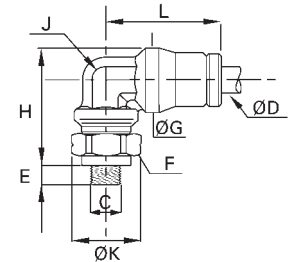

Male Branch Tee – Fractional Inch Tube To UNF To Tube

ØD in	C UNF	Cat. No.	E in	F mm	G in	H in	J in	K in	L in	Scale oz
5/32	10-32	PCNB6803-02.5-10/32-0	.13	10	.39	1.00	.28	.47	.71	.69

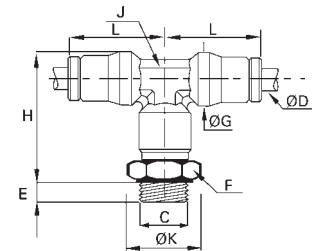

Push-To-Connect

Male Run Tee – Fractional Inch Tube To Tube To UNF

$\varnothing D$ in	C UNF	Cat. No.	E in	F mm	G in	H1 in	H2 in	J in	K in	L in	Scale oz
5/32	10-32	PCNB6804-02.5-10/32-0	.13	10	.39	.71	.81	.28	.47	.91	.69

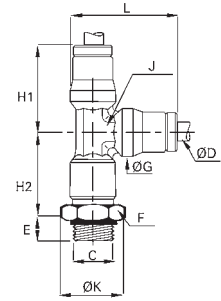

Plug-In Reducer – Fractional Inch

$\varnothing D1$ in	$\varnothing D2$ in	Cat. No.	G in	L in	L1 in	L2 in	Scale oz
5/32	1/4	PCNB2406-02.5-04	.39	1.36	.75	.69	.27
5/32	5/16	PCNB2406-02.5-05	.39	1.40	.79	.71	.35
1/4	3/8	PCNB2406-04-06	.49	1.46	.79	.77	.54
1/4	1/2	PCNB2406-04-08	.49	1.71	.98	.83	.55
3/8	1/2	PCNB2406-06-08	.67	1.97	1.02	1.04	1.26

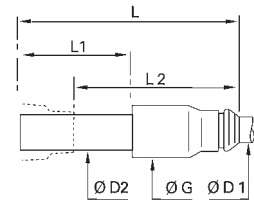

SAE and DOT Push-To-Connect Fittings For Vehicle Applications

Union – Fractional Inch Tube To Tube

$\varnothing D$ Tube	Cat. No.	G in	L in	Scale oz
5/32	PCDT2403-02.5-02.5	.334	.98	.070
3/16	PCDT2403-03-03	.427	1.44	.280
1/4	PCDT2403-04-04	.427	1.16	.140
3/8	PCDT2403-06-06	.630	1.69	.950
1/2	PCDT2403-08-08	.87	2.22	1.15

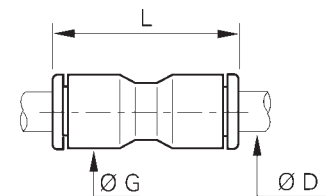

Male Connector – Fractional Inch Tube To Male NPT

ØD in	C NPT	Cat. No.	F mm	H in	K in	Scale oz
5/32	1/8	PCDT2404-02.5-02	11	.334	.472	.220
5/32	1/4	PCDT2404-02.5-04	14	.275	.590	.510
3/16	1/8	PCDT2404-03-02	7/16"	.610	.490	.230
3/16	1/4	PCDT2404-03-04	9/16"	.590	.628	.480
1/4	1/8	PCDT2404-04-02	11	.472	.472	.230
1/4	1/4	PCDT2404-04-04	14	.374	.590	.480
1/4	3/8	PCDT2404-04-06	18	.295	.768	.860
3/8	1/8	PCDT2404-06-02	16	.914	.690	.660
3/8	1/4	PCDT2404-06-04	16	.827	.690	.680
3/8	3/8	PCDT2404-06-06	18	.710	.768	.930
3/8	1/2	PCDT2404-06-08	22	.630	.945	1.70
1/2	1/4	PCDT2404-08-04	22	1.31	.85	1.40
1/2	3/8	PCDT2404-08-06	22	1.31	.85	1.40
1/2	1/2	PCDT2404-08-08	22	1.31	.85	1.60

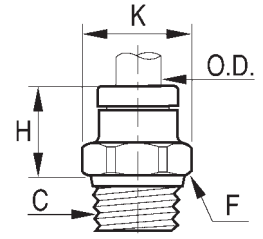

Straight Female Connector – Fractional Inch Tube To NPT

ØD Tube	C NPT	Cat. No.	F mm	G in	H in	E in	Scale oz
5/32	1/8	PCDT2405-02.5-02	13	.326	.89	.374	.350
5/32	1/4	PCDT2405-02.5-04	16	.326	1.06	.551	.560
3/16	1/8	PCDT2405-03-02	9/16"	.45	1.01	.374	.370
1/4	1/8	PCDT2405-04-02	13	.421	.98	.374	.390
1/4	1/4	PCDT2405-04-04	16	.421	1.16	.551	.560
3/8	1/4	PCDT2405-06-04	16	.610	1.44	.551	2.50
3/8	3/8	PCDT2405-06-06	22	.610	1.56	.650	2.58

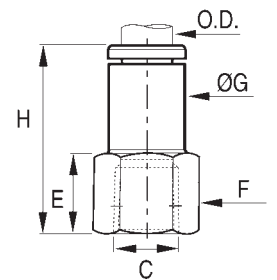

Union Elbow – Fractional Inch Tube To Tube

ØD Tube	Cat. No.	G in	L in	Scale oz
5/32	PCDT2500-02.5-02.5	.334	.75	.070
3/16	PCDT2500-03-03	.427	1.07	.280
1/4	PCDT2500-04-04	.427	.93	.140
3/8	PCDT2500-06-06	.630	1.36	.950
1/2	PCDT2500-08-08	.87	1.84	1.45

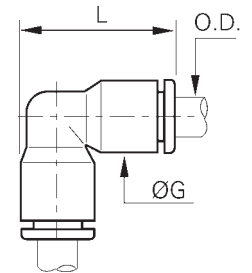

Push-To-Connect

Male Elbow – Fractional Inch Tube To Male NPT

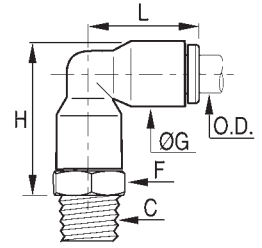

ØD in	C NPT	Cat. No.	F mm	G in	H in	L in	Scale oz
5/32	1/8	PCDT2501-02.5-02	11	.334	.905	.75	.370
3/16	1/8	PCDT2501-03-02	11	.427	1.09	.86	.490
1/4	1/8	PCDT2501-04-02	11	.427	1.09	.93	.490
1/4	1/4	PCDT2501-04-04	14	.427	1.09	.93	.690
1/4	3/8	PCDT2501-04-06	18	.427	1.18	.93	1.01
3/8	1/4	PCDT2501-06-04	17	.630	1.54	1.33	1.09
3/8	3/8	PCDT2501-06-06	18	.630	1.54	1.33	1.60
3/8	1/2	PCDT2501-06-08	22	.630	1.54	1.33	2.80
1/2	1/4	PCDT2501-08-04	7/8"	.87	1.95	1.59	1.80
1/2	3/8	PCDT2501-08-06	7/8"	.87	1.95	1.59	2.00
1/2	1/2	PCDT2501-08-08	1"	.87	1.95	1.59	2.20

Male Branch Tee – Fractional Inch Tube To Male NPT

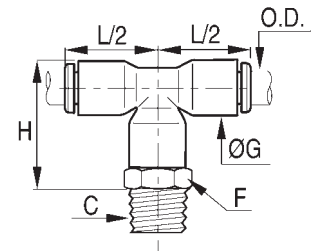

ØD in	C NPT	Cat. No.	F mm	G in	H in	L 2 in	Scale oz
5/32	1/8	PCDT2601-02.5-02.5-02	11	.334	.905	.57	.420
5/32	1/4	PCDT2601-02.5-02.5-04	14	.334	.905	.57	.720
3/16	1/8	PCDT2601-03-03-02	11	.427	1.09	.85	.570
1/4	1/8	PCDT2601-04-04-02	11	.427	1.09	.71	.570
1/4	1/4	PCDT2601-04-04-04	14	.427	1.09	.71	.770
1/4	3/8	PCDT2601-04-04-06	18	.427	1.18	.71	1.13
3/8	1/4	PCDT2601-06-06-04	17	.630	1.54	1.04	1.21
3/8	3/8	PCDT2601-06-06-06	18	.630	1.54	1.04	1.78
3/8	1/2	PCDT2601-06-06-08	22	.630	1.54	1.04	2.94
1/2	1/4	PCDT2601-08-08-04	7/8"	.87	1.52	1.41	2.20
1/2	3/8	PCDT2601-08-08-06	7/8"	.87	1.52	1.41	2.70
1/2	1/2	PCDT2601-08-08-08	1"	.87	1.52	1.41	2.80

Union Tee – Fractional Inch Tube To Tube To Tube

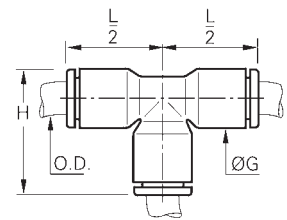

ØD Tube	Cat. No.	G in	H in	L/2 in	Scale oz
5/32	PCDT2603-02.5-02.5-02.5	.334	.728	.57	.140
3/16	PCDT2603-03-03-03	.427	1.02	.85	.420
1/4	PCDT2603-04-04-04	.427	.905	.93	.490
3/8	PCDT2603-06-06-06	.630	1.33	1.05	1.48
1/2	PCDT2603-08-08-08	.87	1.81	1.41	2.00

Male Run Tee – Fractional Inch Tube To Male NPT

ØD Tube	C NPT	Cat. No.	F mm	G in	H in	H1 in	L in	Scale oz
5/32	1/8	PCDT2605-02.5-02-02.5	11	.334	1.34	.736	.57	.420
5/32	1/4	PCDT2605-02.5-04-02.5	14	.334	1.34	.736	.57	.720
3/16	1/8	PCDT2605-03-02-03	11	.427	1.73	.874	.85	.570
1/4	1/8	PCDT2605-04-02-04	11	.427	1.60	.870	.71	.570
1/4	1/4	PCDT2605-04-04-04	14	.427	1.60	.870	.71	.770
1/4	3/8	PCDT2605-04-06-04	18	.427	1.60	.964	.71	1.13
3/8	1/4	PCDT2605-06-04-06	17	.630	2.30	1.22	1.06	1.21
3/8	3/8	PCDT2605-06-06-06	18	.630	2.30	1.22	1.06	1.78
3/8	1/2	PCDT2605-06-08-06	22	.630	2.30	1.22	1.06	2.94
1/2	1/4	PCDT2605-08-04-08	7/8"	.87	2.95	1.51	1.40	2.40
1/2	3/8	PCDT2605-08-06-08	7/8"	.87	2.95	1.51	1.40	2.70
1/2	1/2	PCDT2605-08-08-08	1"	.87	2.95	1.51	1.40	2.80

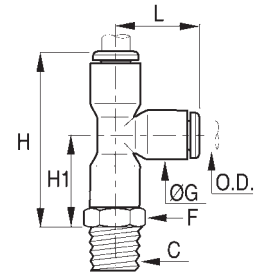

Bulkhead Union – Fractional Inch

ØD Tube	Cat. No.	F mm	K MAX in	L1 in	L2 in	T min in	Max Torque	Scale oz
5/32	PCDT2700-02.5-02.5	13	.216	.37	.571	.413	11 lb in	.670
1/4	PCDT2700-04-04	15	.334	.37	.768	.492	13 lb in	1.02
3/8	PCDT2700-06-06	22	.571	.53	1.18	.728	22 lb in	2.96
1/2	PCDT2700-08-08	29	.82	.69	1.64	1.02	39 lb in	3.60

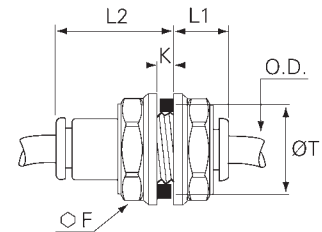

“Y” Male Connector – Fractional Inch Tube To NPT

ØD Tube	C NPT	Cat. No.	F mm	H in	G in	L in	N in	Scale oz
5/32	1/8	PCDT2801-02.5-02.5-02	11	.689	.334	1.30	.354	.350
5/32	1/4	PCDT2801-02.5-02.5-04	14	.689	.334	1.32	.354	.630
1/4	1/8	PCDT2801-04-04-02	11	.866	.433	1.65	.453	.630
1/4	1/4	PCDT2801-04-04-04	14	.866	.433	1.60	.453	.750

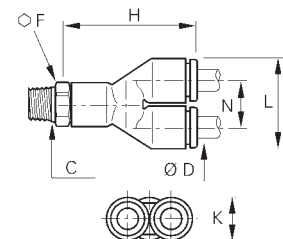

Union “Y” – Fractional Inch Tube To Tube

ØD Tube	Cat. No.	H in	K in	L in	N in	Scale oz
5/32	PCDT2803-02.5-02.5	.689	.334	1.12	.354	.140
1/4	PCDT2803-04-04	.878	.433	1.42	.453	.350
3/8	PCDT2803-06-06	1.30	.630	2.12	.669	.520

