

Check valve with SAE adapter Steel / Stainless Steel

RVZ-SAE

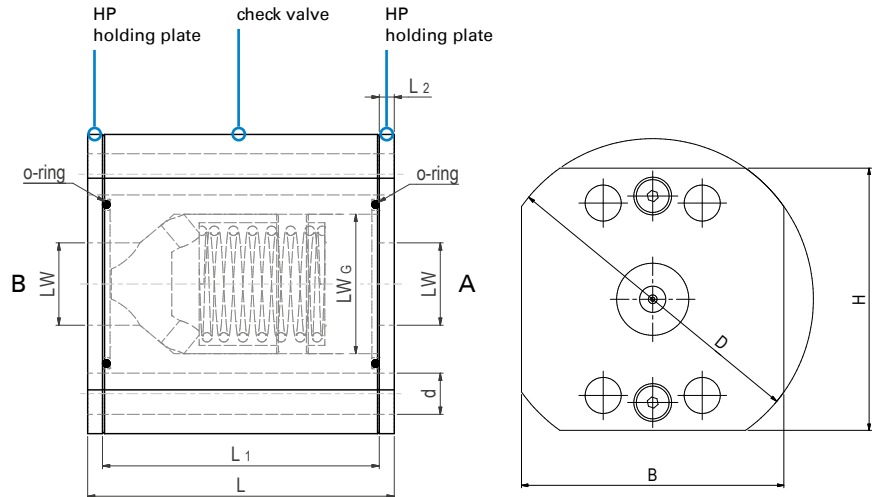
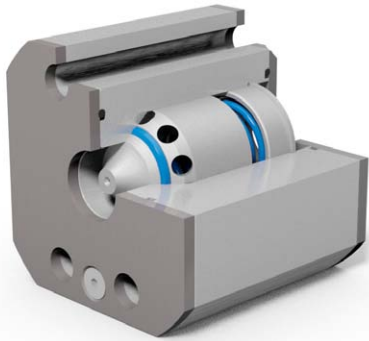

AVAILABLE SIZES

DN15 - DN50 (5/8" to 2")

CONNECTIONS

ISO 6162-1, ISO 6162-2

PORTING PATTERN

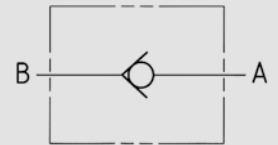

ACCESSORIES ON REQUEST

- Double flange pattern adapter plate page 216

MATERIAL CODE DESCRIPTION

Materials	28p8	44p8
Body	Steel	Stainless Steel
Poppet	Steel	Stainless Steel
Seat	Polyurethane	Polyurethane
O-rings	FPM	FPM
Tmin /Tmax	-20°C / 100°C	-20°C / 100°C
Cracking pressure	2 bar	2 bar

GENERAL DIMENSIONS

Type	LW	LW _G	L	L ₁	D	B	H	PÖ [bar]
RVZ-DN15-SAE210	11	17,5	46	38	70	45	60	2
RVZ-DN20-SAE210	14,5	23	54	46	82	55	70	2
RVZ-DN25-SAE210	17	28	61	53	97	70	80	2
RVZ-DN32-SAE210	22	37,3	82	74	98	80	80	2
RVZ-DN40-SAE210	28	43	89	81	118	90	95	2
RVZ-DN50-SAE210	37	55	105	97	137	100	110	2
RVZ-DN15-SAE420	11	17,5	46	38	73	50	60	2
RVZ-DN20-SAE420	14,5	23	54	46	87	60	70	2
RVZ-DN25-SAE420	17	28	61	53	98	70	80	2
RVZ-DN32-SAE420	22	37,3	84	74	115	80	95	2
RVZ-DN40-SAE420	28	43	91	81	136	95	115	2
RVZ-DN50-SAE420	37	55	109	97	165	115	135	2

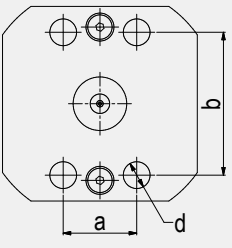
CONNECTION TYPE	DIMENSIONS					ORDER CODE PER MATERIAL COMBINATION		
	Type	a	b	d	Weight [Kg]	PN [bar]	28p8	44p8
	RVZ-DN15-SAE210	17,5	38,1	9	1,10	210	55424	on request
	RVZ-DN20-SAE210	22,2	47,6	11	1,50	210	55425	on request
	RVZ-DN25-SAE210	26,2	52,4	11	2,30	210	55394	on request
	RVZ-DN32-SAE210	30,2	58,7	11	3,45	210	55395	on request
	RVZ-DN40-SAE210	35,7	69,9	13	4,85	210	54350	on request
	RVZ-DN50-SAE210	42,9	77,8	13	7,80	210	55426	on request

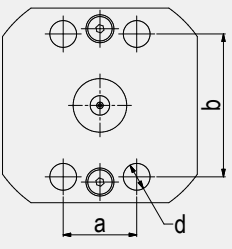
CONNECTION TYPE	DIMENSIONS					ORDER CODE PER MATERIAL COMBINATION		
	Type	a	b	d	Weight [Kg]	PN [bar]	28p8	44p8
	RVZ-DN15-SAE420	18,2	40,5	9	1,10	420	55732	on request
	RVZ-DN20-SAE420	23,8	50,8	11	1,50	420	55731	on request
	RVZ-DN25-SAE420	27,8	57,2	13	2,30	420	55721	on request
	RVZ-DN32-SAE420	31,8	66,7	13	3,45	420	55716	on request
	RVZ-DN40-SAE420	36,5	79,4	17	4,85	420	55022	on request
	RVZ-DN50-SAE420	44,5	96,8	22	7,80	420	55726	on request

Scope of delivery

- Check valve + 2 O-rings + 2 holding plates
- Adapter plate has to be ordered separately (see next page)
- Standard cracking pressure 2 bar, further cracking pressures on request

OPTIONS THAT CAN BE REALIZED WITH SCOPE OF DELIVERY

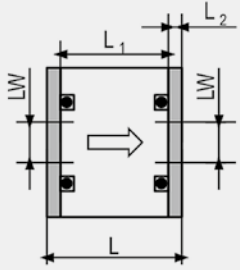

Option A
without seals

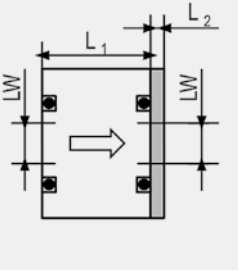

Option B
inlet side sealed

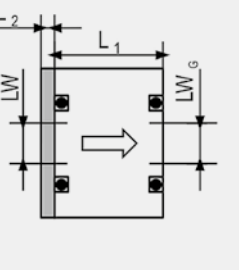

Option C
outlet side sealed

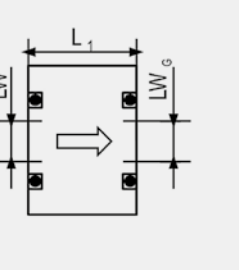

Option D
seals on both sides

on request

Option E
with threaded holes

⚠ Due to spring and manufacturing tolerances cracking pressures may deviate by ±30%.

⚠ Leakage rate of check valve DIN EN 12266 leakage rate A - no visually noticeable leakage during the duration of the test with fluid or air.